

Features

- § forward current $\leq 30\text{Ma}$
- § Wide viewing angle: 120°
- § Operating Temperature $-40\sim 80^\circ\text{C}$
- § Storage temperature $-40\sim 100^\circ\text{C}$
- § ROHS and REACH-compliant
- § Junction Temperature 110°C
- § PACKAGE: 2000 PCS/REEL.
- § Qualified according to JEDEC moisture vity Level 3
- § Chip material: AlGaInP
- § Reverse Voltage: 5V
- § Duty 1/10 · Pulse Width 0.1ms

Power Product Identification Code

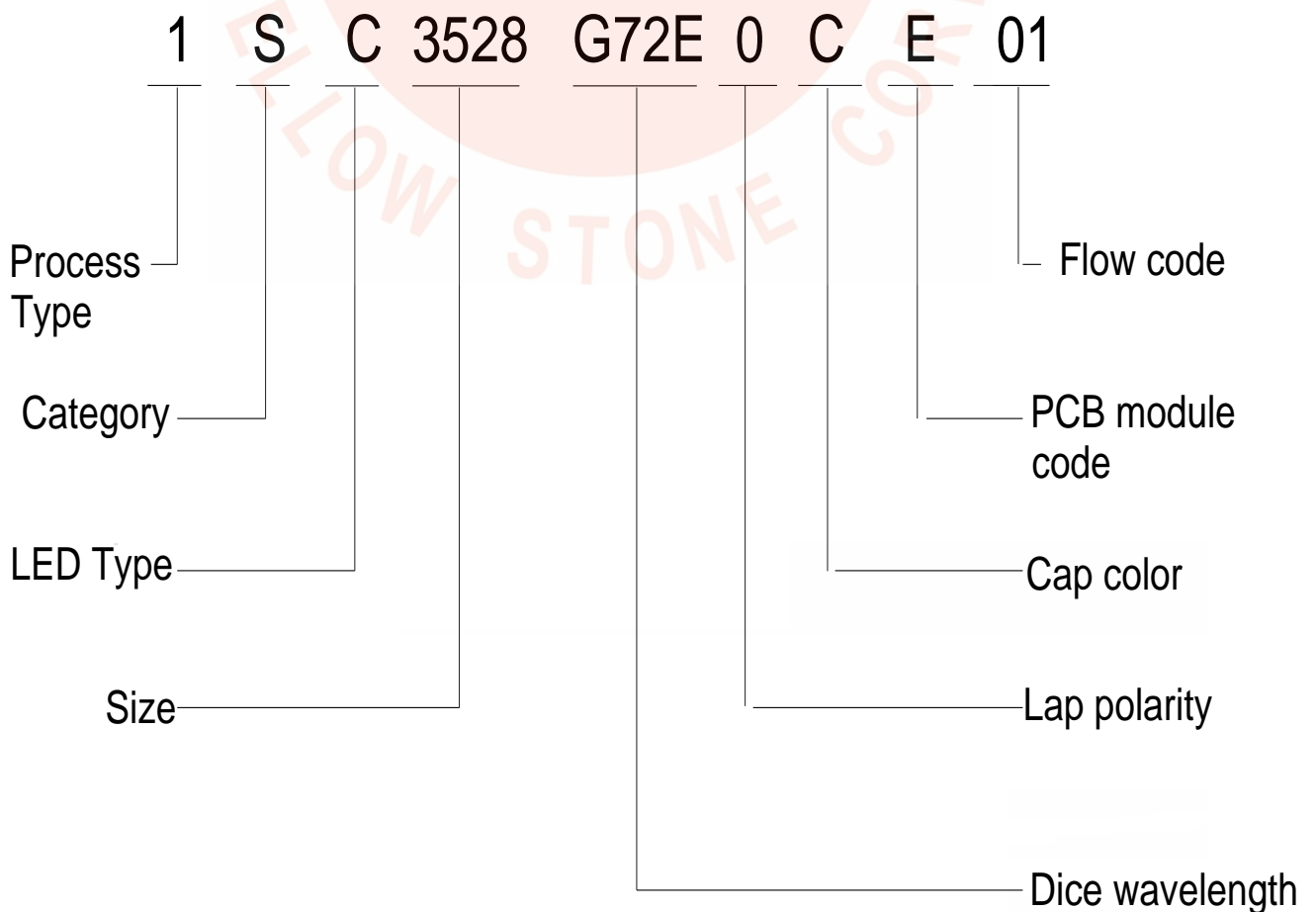

Electrical-Optical Characteristics (Ta=25°C)

Parameter	Symbol	Value			Unit	Test condition
		Min.	Typ.	Max.		
Forward Voltage	V _f	2.8	3.2	3.6	V	I _f =20mA
Luminous intensity	I _v	1000	1700		mcd	I _f =20mA
Wavelength	λ d	520		535	nm	I _f =20mA
Reverse Current	I _r	---	---	10	μ A	V _r =5V
Viewing angle	2θ 1/2	---	120	---	Deg	I _f =20mA

▲Luminous intensity (I_v) ±10%, Forward Voltage (V_f) ±0.1V, Wavelength(λd) ±0.5nm

▲IS standard testing

Range of bins

Bin	BinB	BinC	BinD	BinE	BinF	BinG	BinH
VF(v)	2.8-2.9	2.9-3.0	3.0-3.1	3.1-3.2	3.2-3.3	3.3-3.4	3.4-3.5
Bin	Bin1						
VF(v)	3.5-3.6						
Bin	Bin15	Bin16	Bin17				
Iv(mcd)	1000-1300	1300-1700	1700-2200				
Bin	G	H	I				
WL(nm)	520-525	525-530	530-535				

Optical Characteristics-1

Relative Spectral Distribution

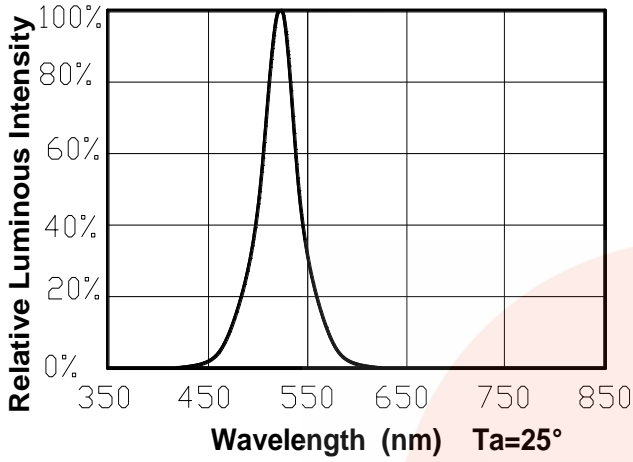

Typical Spatial Distribution

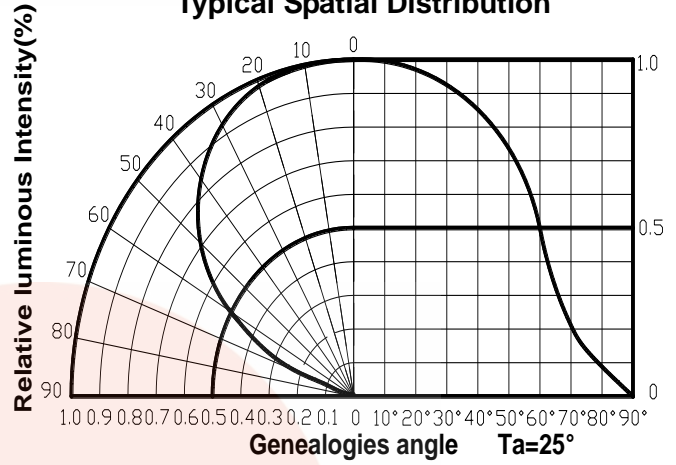

Relative Luminous Flux .Current Ta=25

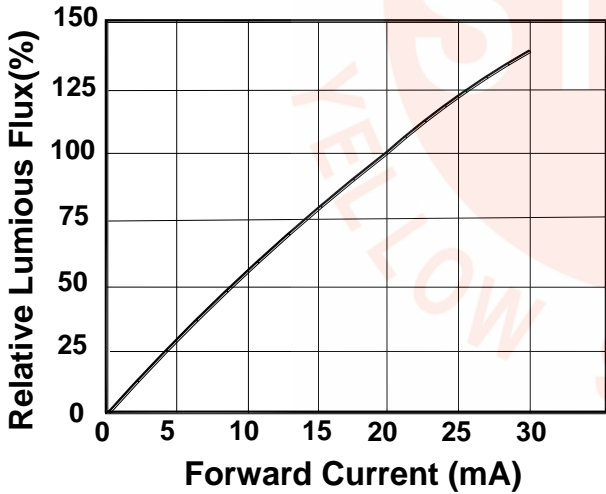

Ta=25°C

Electrical Characteristics

Relative Luminous Flux .Ambient Temperature

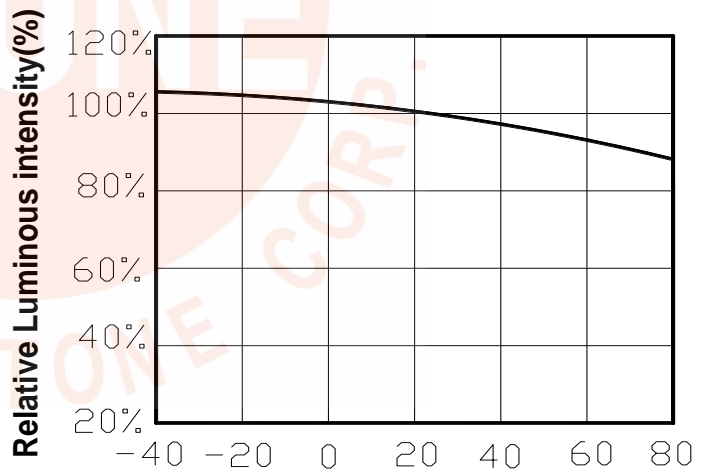

Ambient Temperature(°)

Thermal Design

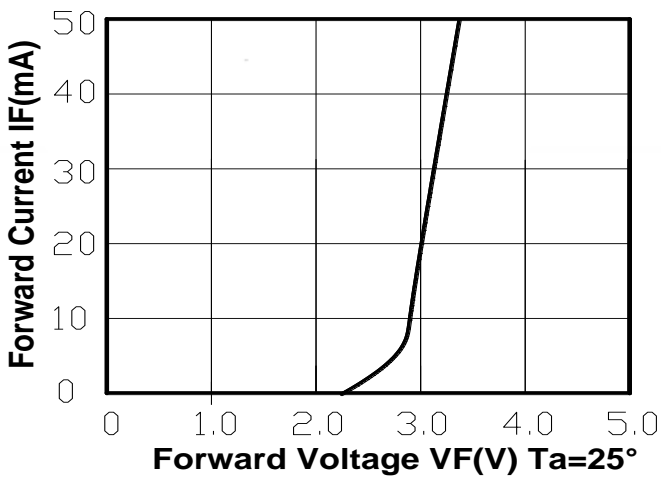

Forward Voltage VF(V) Ta=25°C

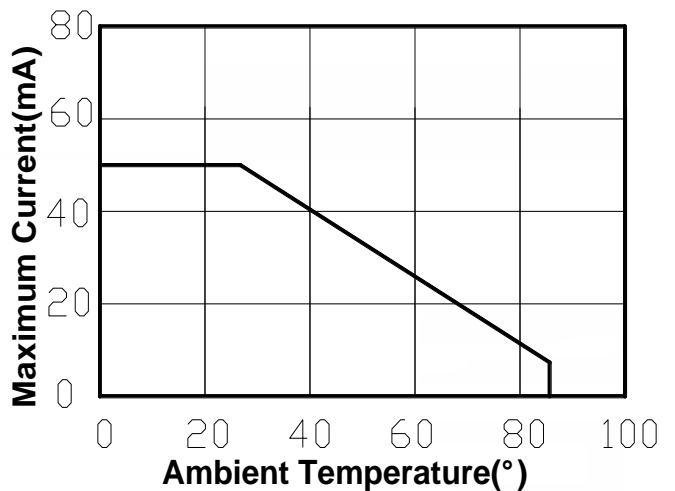

Ambient Temperature(°)

Optical Characteristics-2

Forward Voltage Temperature

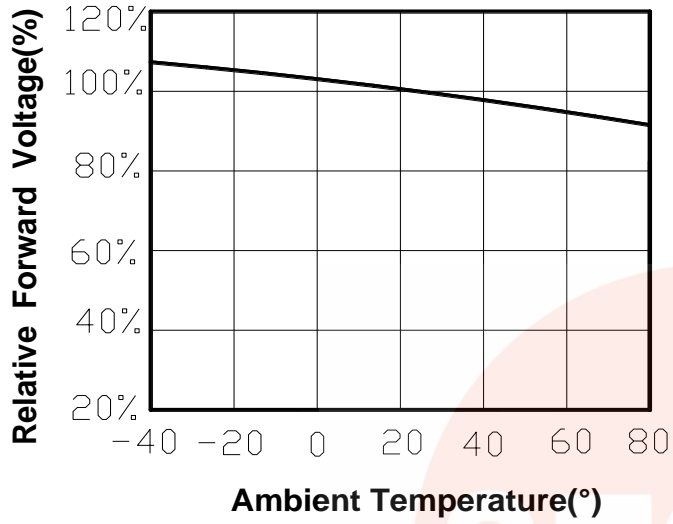

Wavelength and current

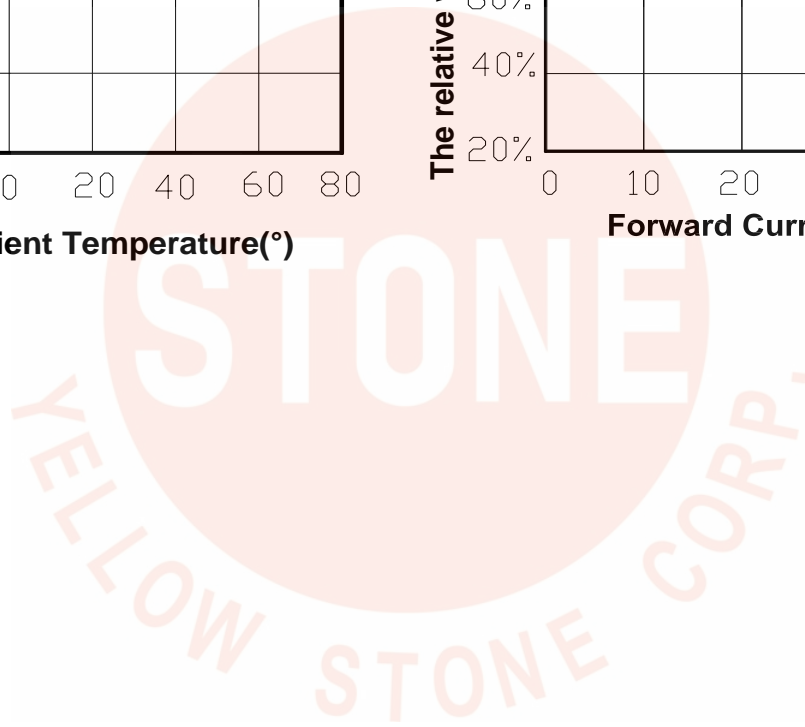
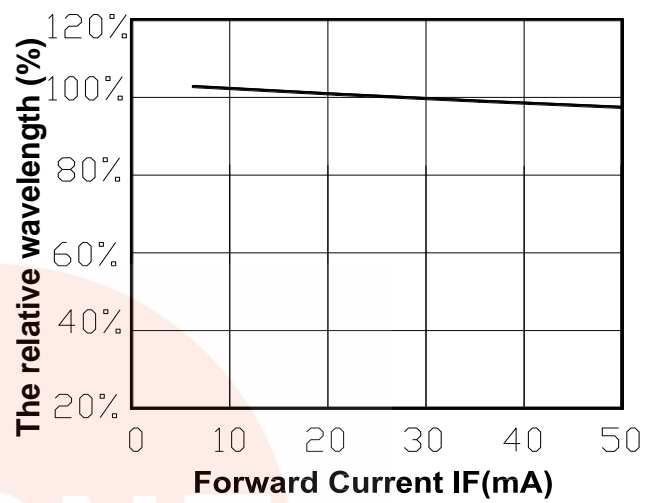

Outline Dimensions

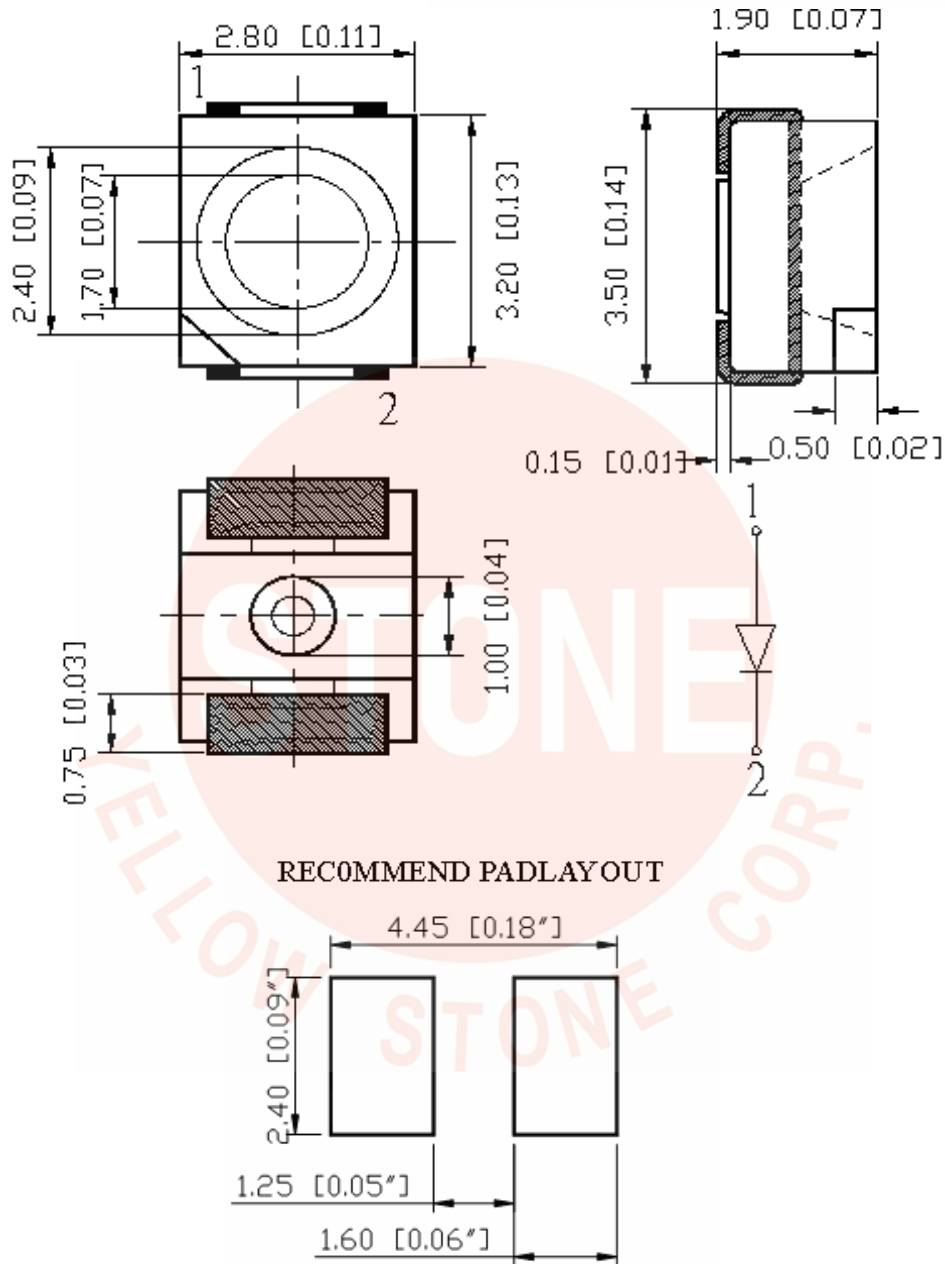

- § All dimensions are in millimeters.(inch)
- § Tolerance is $\pm 0.1(0.004)$ mm unless other specified
- § Specifications are subject to change without notice.

Reflow Profile

1. IR reflow soldering Profile Lead Free solder

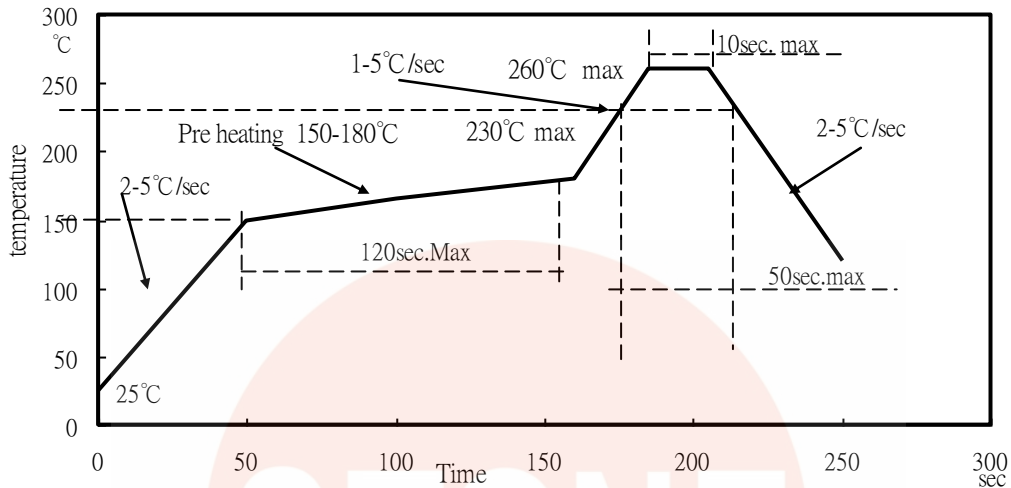

2. IR reflow soldering Profile Lead solder

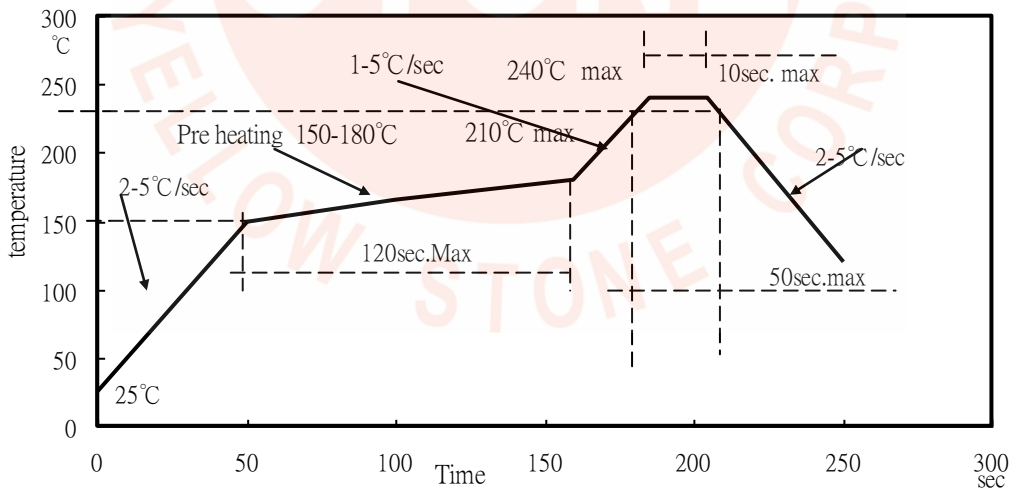

NOTES:

1. We recommend the reflow temperature 240°C (±5°C). the maximum soldering temperature should be limited to 260°C.
2. Don't cause stress to the silicone resin while it is exposed to high temperature.
3. Number of reflow process shall be 1 time.

Test circuit and handling precautions

■ Test circuit

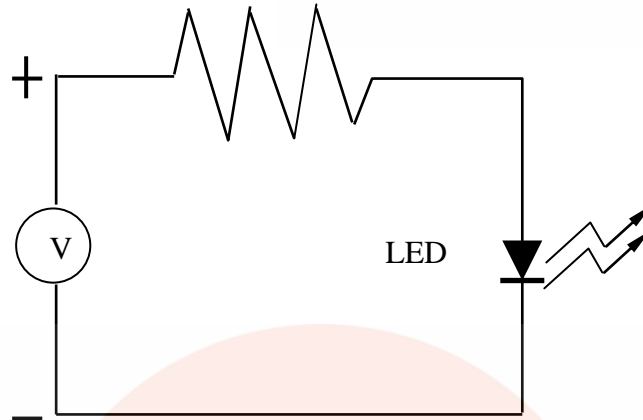

■ Handling precautions

1. Over-current-proof

Customer must apply resistors for protection; otherwise slight voltage shift will cause big current change (Burn out will happen).

2.Storage

2.1 It is recommended to store the products in the following conditions:

Humidity: 60% R.H. Max.

Temperature : 5°C~30°C (41°F~86°F)

2.2 Shelf life in sealed bag: 12 month at <5°C~30°C and <60% R.H. after the package is

Opened, the products should be used within a week or they should be keeping to stored at $\leq 20\%R.H.$ with zip-lock sealed.

3.Baking

It is recommended to baking before soldering when the pack is unsealed after 24hrs. The

Conditions are as followings:

3.1 70±3°C x 24hrs and <5%RH, taped reel type

3.2 100±3°C x 2hrs , bulk type

3.3 130±3°C x(15~30min), bulk type

It shall be normal to see slight color fading of carrier(light yellow) after baking in process

Packing-1

3528 Single-Color High Performance SMD Top LEDs Packaging Specifications

● Dimensions of Reel (Unit: mm)

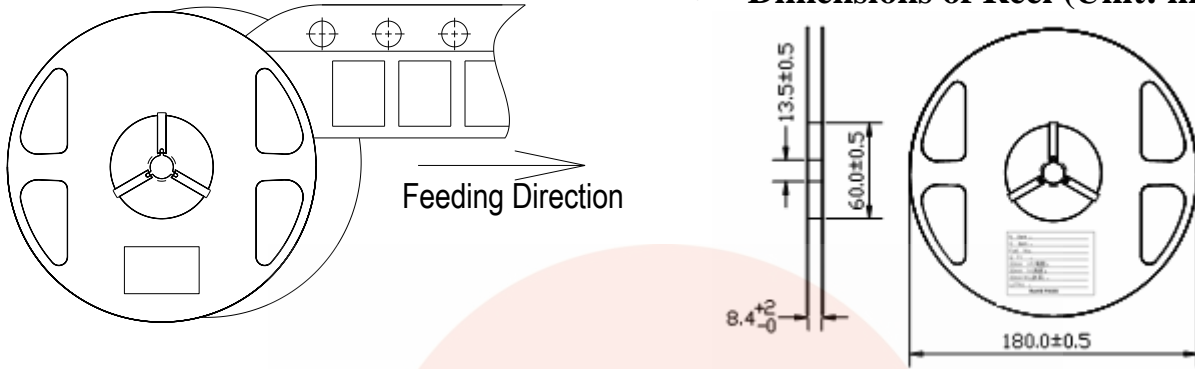

● Dimensions of Tape (Unit: mm)

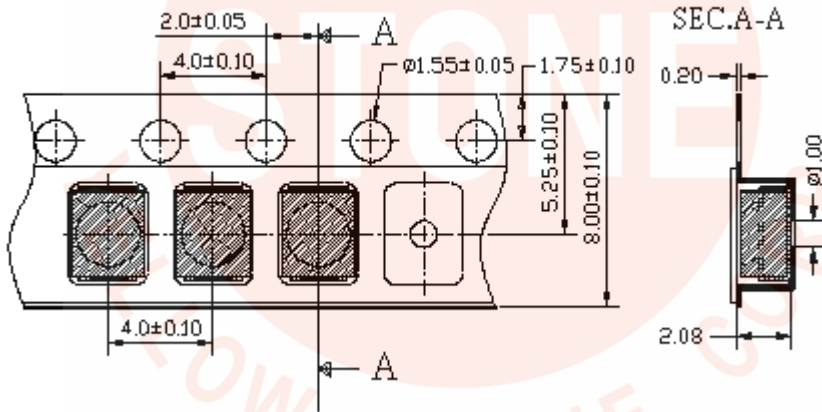

● Arrangement of Tape

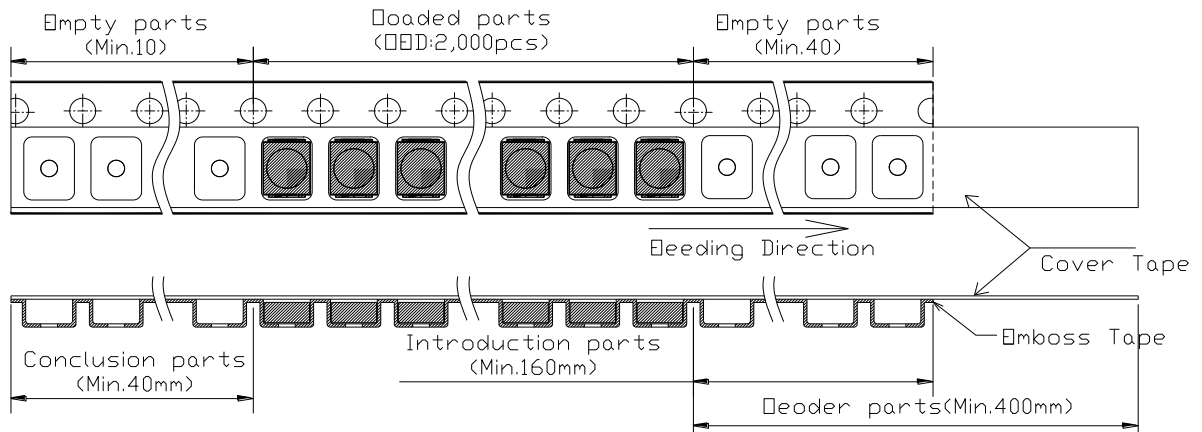

NOTES

1. Empty component pockets are sealed with top cover tape;
2. The maximum number of missing lamps is two;
3. The cathode is oriented towards the tape sprocket hole in accordance with ANSI/EIA RS-481 specifications;
4. 2,000pcs/Reel

Packing-2

3528 Single-Color High Performance SMD Top LEDs Packaging Specifications

● Packaging specifications

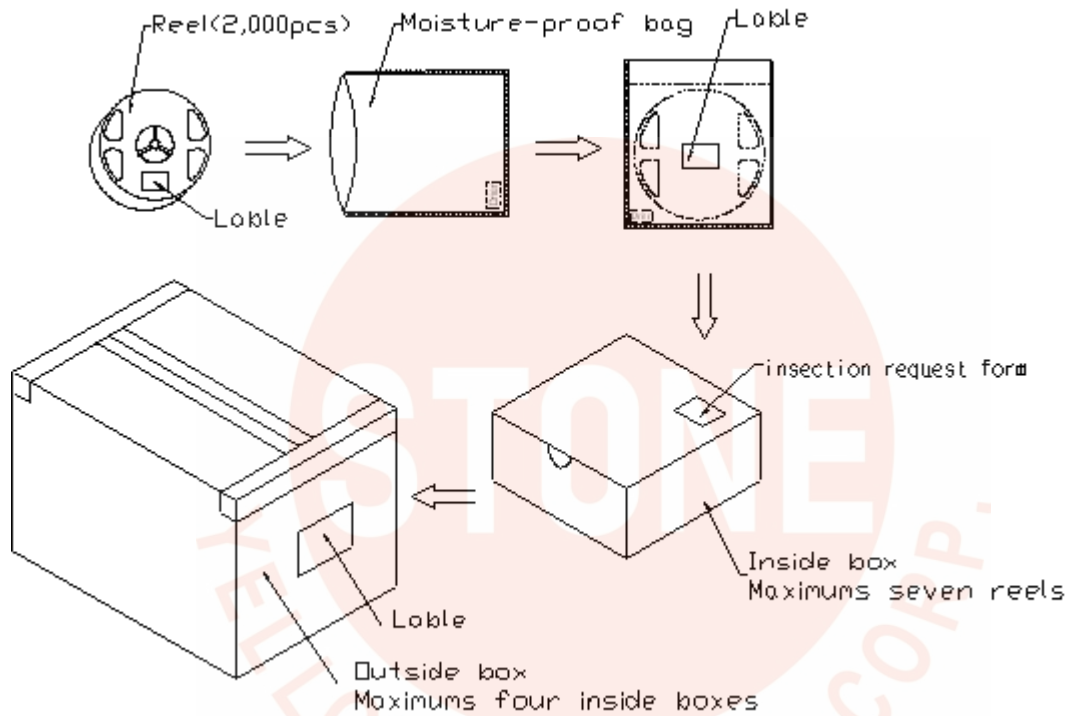

NOTES:

Reeled products (The most numbers of products are 2,000pcs) packed in a seal off moisture-proof bag along with a desiccant one by one, Seven moisture-proof bag of maximums (total maximum number of products are 14,000pcs) packed in an inside box (size: about 238mm x about 194mm x about 102mm) and four inside boxes of maximums are put in the outside box (size: about 410mm x about 254mm x about 229mm) Together with buffer material, and it is packed. (Part No., Lot No., quantity should appear on the label on the moisture-proof bag, part No. And quantity should appear on the in section request form on the cardboard box.) .

Precautions

1、Abnormal situation caused by improper setting of collet

To choose the right collet is the key issue in improving the product's quality. LED is different from other electronic components, which is not only about electrical output but also for optical output. This characteristic made LED more fragile in the process of SMT. If the collet's lowering down height is not well set, it will bring damage to the gold wire at the time of collet's picking up and loading which will cause the LED fail to light up, light up now and then or other quality problems

2、How to choose the collet

During SMT, please choose the collet that has larger outer diameter than the lighting area of lens, in case that improper position of collet will damage the gold wire inside the LED. Different collets fit for different products, please refer to the following pictures cross out:.

Outer diameter of collet should be larger than the lighting area

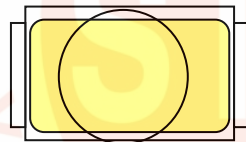

Picture 1 (√)

Outer diameter of collet

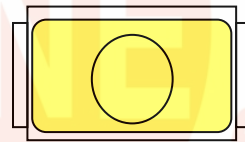

Picture 2 (×)

3、How to set the height of collet

The reason why for top view SMD, the height of collet before it presses downward will directly affect the quality of products during SMT is that if the collect go down too much, it will press lens and cause the distortion or breaking of gold wire. The setting of collet position should follow the pictures belowed.

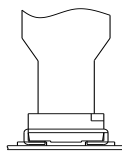

Picture 3 (√)

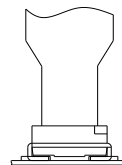

Picture 4 (×)

No.3、Other points for attention

- A、No pressure should be exerted to the epoxy shell of the SMD under high temperature.
- B、Do not scratch or wipe the lens since the lens and gold wire inside are rather fragile and cross out easy to break.
- C、LED should be used as soon as possible when being taken out of the original package, and should be stored in anti-moisture and anti-ESD package.

No.4、This usage and handling instruction is only for your reference.

Test items and results of reliability

Type	Test Item	Test Standard	Test Conditions	Note	Number of Damaged
Environmental Sequence	Temperature Cycle	JEITA ED-4701 300 303	-40°C 30min ↑↓5 min 100°C 30min	100 cycle	0/50
	Thermal Shock	JEITA ED-4701 200 303	-10°C 15min ↑↓5sec 100°C 15min	20 cycle	0/22
	High Temperature Storage	JEITA ED-4701 200 201	T _a =100°C	1000 hrs	0/22
	Humidity Heat Storage	JEITA ED-4701 100 103	T _a =60°C RH=90%	1000 hrs	0/22
	Low Temperature Storage	JEITA ED-4701 200 202	T _a =-40°C	1000 hrs	0/22
Operation Sequence	Life Test	Tested with Brightek standard	T _a =25°C I _F =20mA	1000 hrs	0/22
	High Humidity Heat Life Test	Tested with Brightek standard	60°C RH=90% I _F =15mA	500 hrs	0/22
	Low Temperature Life Test	Tested with Brightek standard	T _a =-20°C I _F =20mA	1000 hrs	0/22

14、Judgment criteria of failure for the reliability

Measuring items	Symbol	Measuring conditions	Judgement criteria for failure
Forward voltage	V _f (V)	I _F =20mA	Over U _x 1.2
Reverse current	I _R (uA)	V _r =5V	Over U _x 2