

## Features

- § forward current  $\leq 50\text{mA}$
- § Wide viewing angle:  $120^\circ$
- § Operating Temperature  $-40\sim 80^\circ\text{C}$
- § Storage temperature  $-40\sim 80^\circ\text{C}$
- § ROHS and REACH-compliant
- § Junction Temperature  $110^\circ\text{C}$
- § PACKAGE: 2000 PCS/REEL.
- § Qualified according to JEDEC moisture level Level 3
- § Chip material: AlGaInP
- § Reverse Voltage: 5V
- § Duty 1/10 · Pulse Width 0.1ms

## Product Identification Code

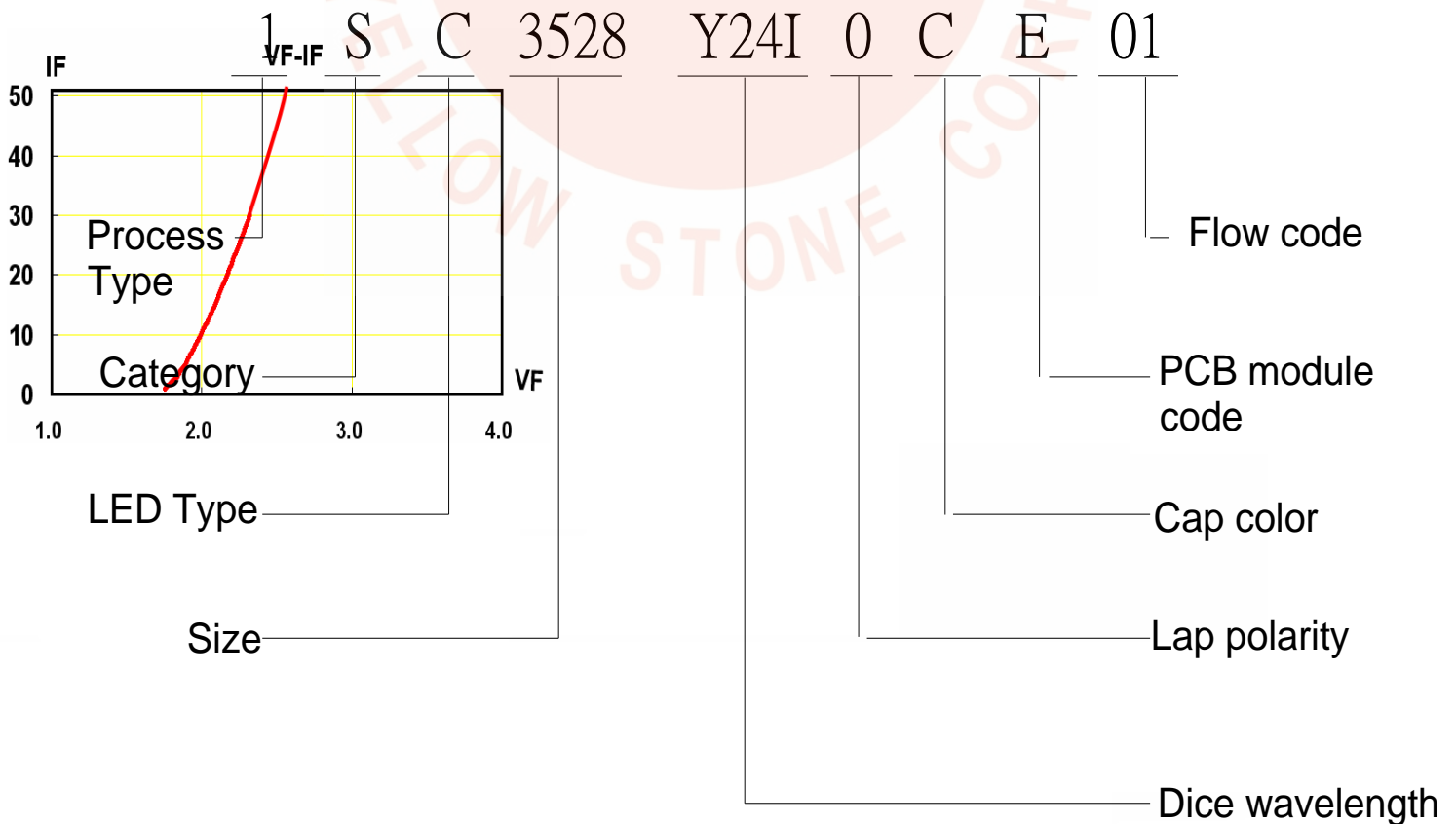

## Electrical-Optical Characteristics (Ta=25°C)

Parameter	Symbol	Value			Unit	Test condition
		Min.	Typ.	Max.		
Forward Voltage	$V_f$		2.0	2.5	V	If=20mA
Luminous intensity	$I_v$	460	800	---	mcd	If=20mA
Wavelength	$\lambda_d$	582		597	(nm)	If=20mA
Reverse Current	$I_r$	---	---	10	$\mu A$	Vr=5V
Viewing angle	$2\theta_{1/2}$	---	120	---	Deg	If=20mA

▲ Luminous intensity (IV)  $\pm 10\%$ , Forward Voltage (VF)  $\pm 0.1V$ , Wavelength( $\lambda_d$ )  $\pm 0.5nm$

▲ IS standard testing

## Range of bins

<b>Bin</b>	BinB	BinC	BinD	BinE	BinF	BinG	
<b>VF(V)</b>	1.8-1.9	1.9-2.0	2.0-2.1	2.1-2.2	2.2-2.3	2.3-2.4	
<b>Bin</b>	Bin4	Bin5	Bin6	Bin7	Bin8	Bin9	Bin10
<b>Iv(mcd)</b>	55-70	70-90	90-120	120-160	160-210	210-270	270-350
<b>Bin</b>	Bin11	Bin12	Bin13	Bin14	Bin15	Bin16	Bin17
<b>Iv(mcd)</b>	350-460	460-600	600-780	780-1000	1000-1300	1300-1700	1700-2200
<b>Bin</b>	Bin18	Bin19	Bin20	Bin21	Bin22	Bin23	Bin24
<b>Iv(mcd)</b>	2200-2800	2800-3600	3600-4600	4600-6000	6000-7800	7800-10100	10100-13130
<b>Bin</b>	Bin25	Bin26					
<b>Iv(mcd)</b>	13130-17000	17000-22100					
<b>Bin</b>	<b>B</b>	<b>C</b>	<b>D</b>	<b>E</b>	<b>F</b>		
<b>WL(nm)</b>	<b>582-585</b>	<b>585-588</b>	<b>588-591</b>	<b>591-594</b>	<b>594-597</b>		

# Optical Characteristics-1

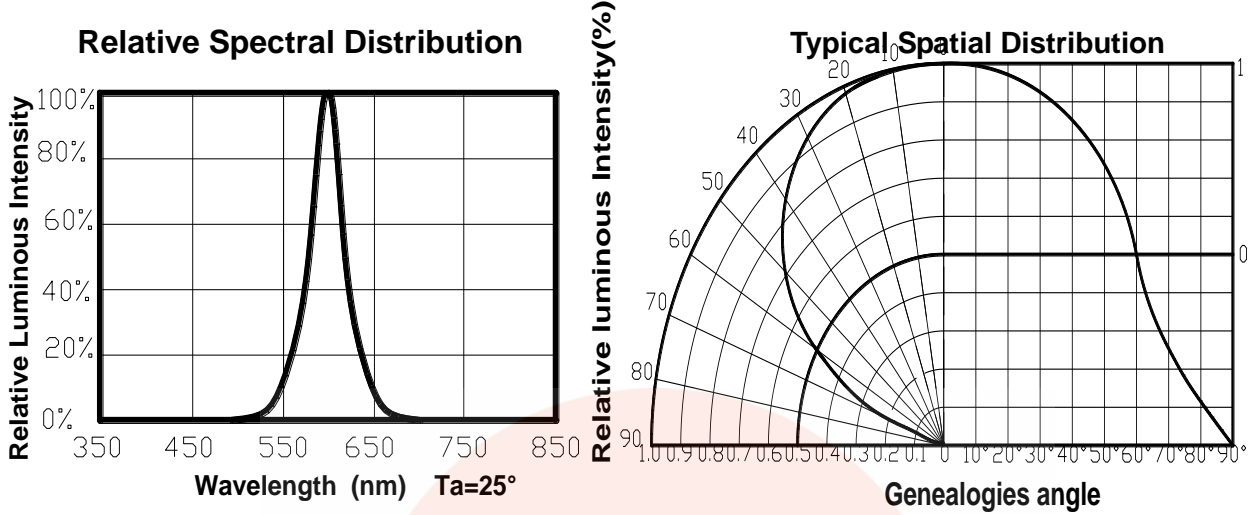

Relative Luminous Flux .Current Ta=25

Relative Luminous Flux .Ambient Temperature

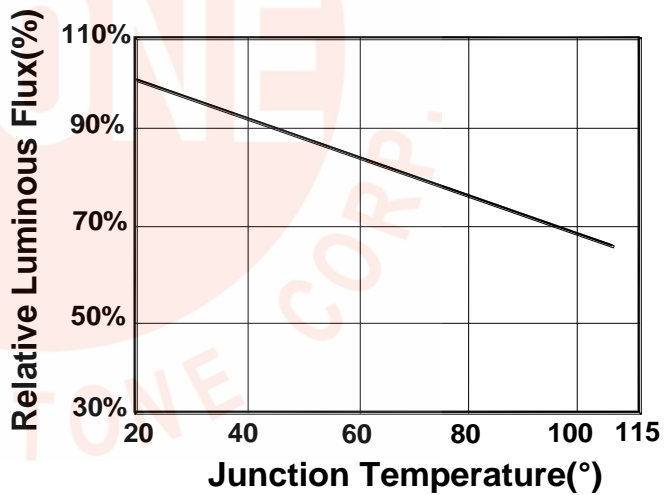
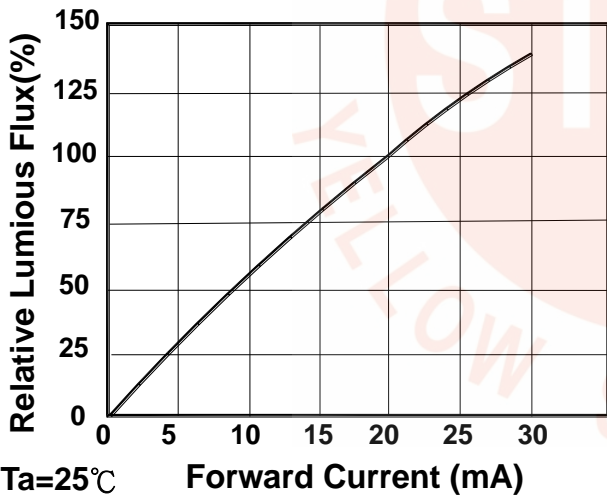

Electrical Characteristics

Thermal Design

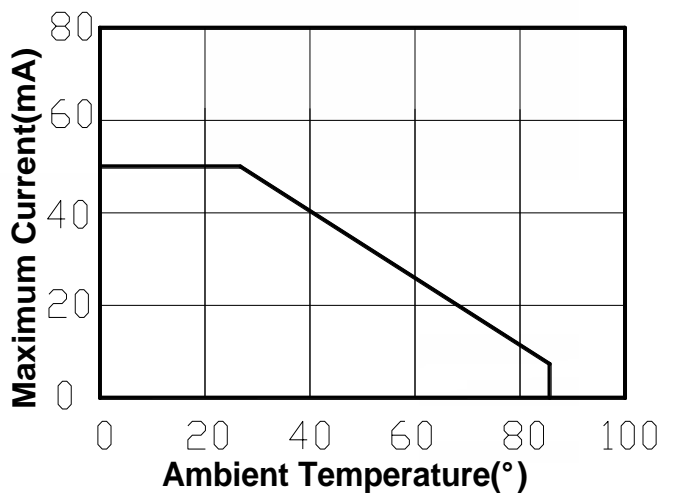
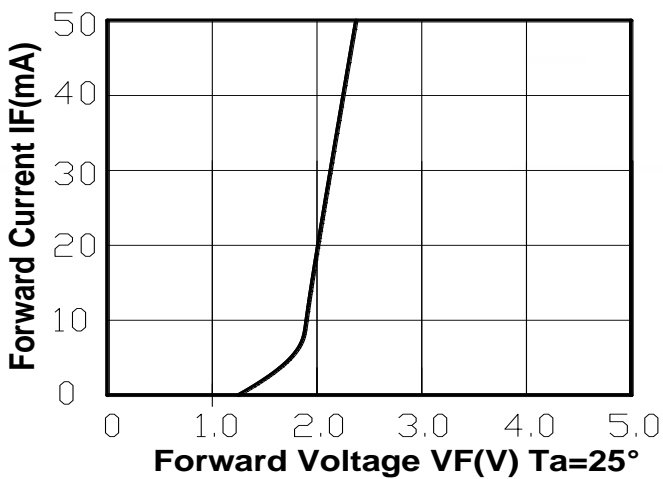

## Optical Characteristics-2

Forward Voltage Temperature

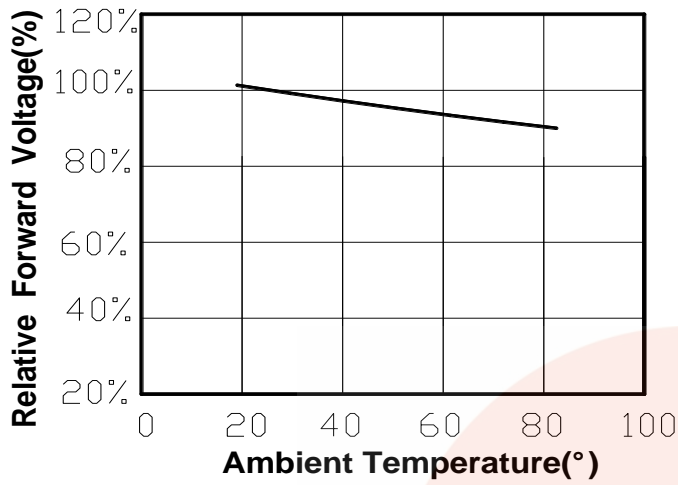

Wavelength and current

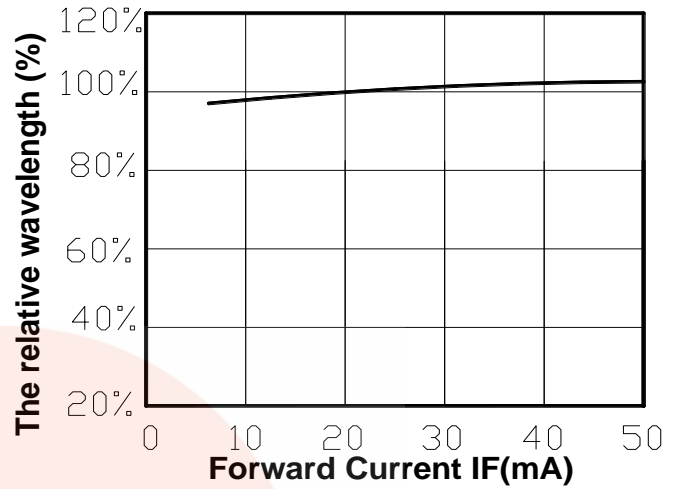

## Outline Dimensions

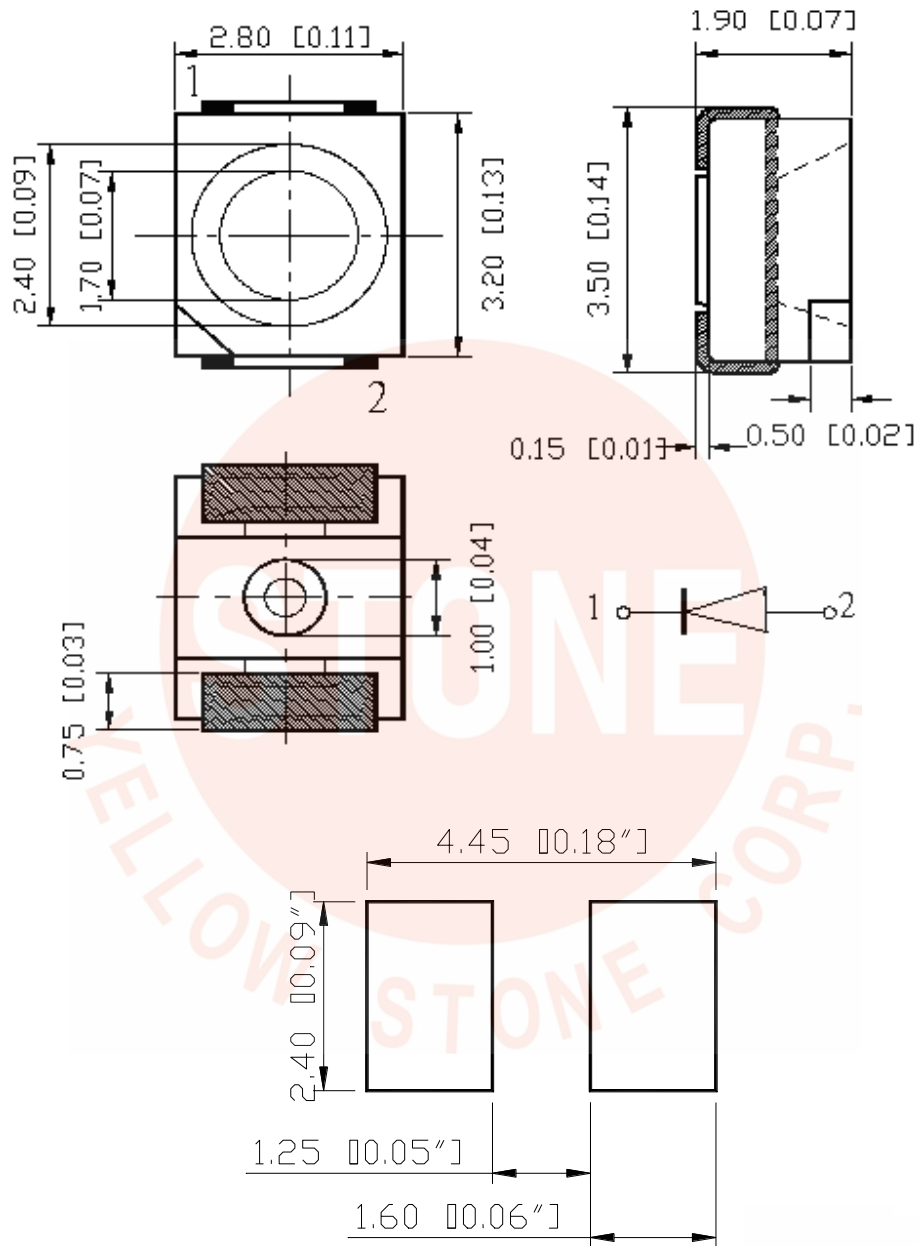

- § All dimensions are in millimeters.(inch)
- § Tolerance is  $\pm 0.1(0.004)$ mm unless other specified
- § Specifications are subject to change without notice.

## Reflow Profile

### 1. IR reflow soldering Profile Lead Free solder

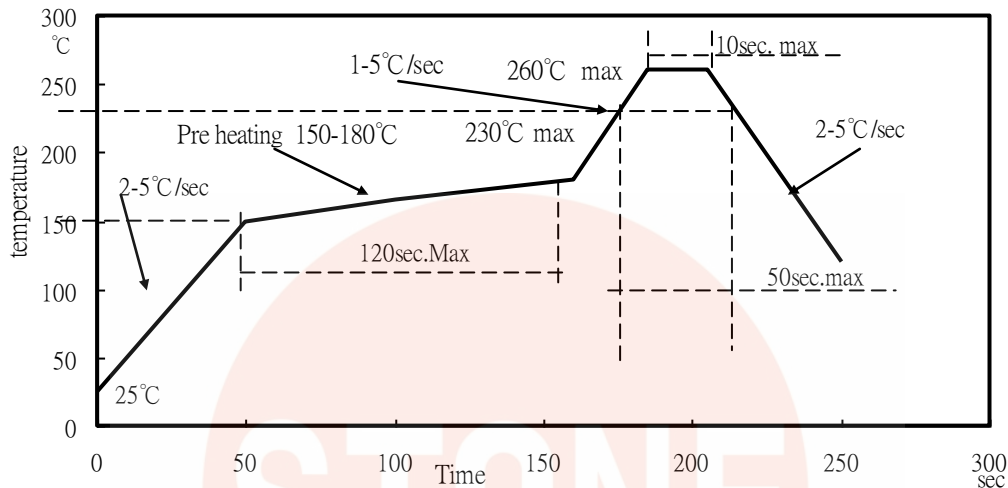

### 2. IR reflow soldering Profile Lead solder

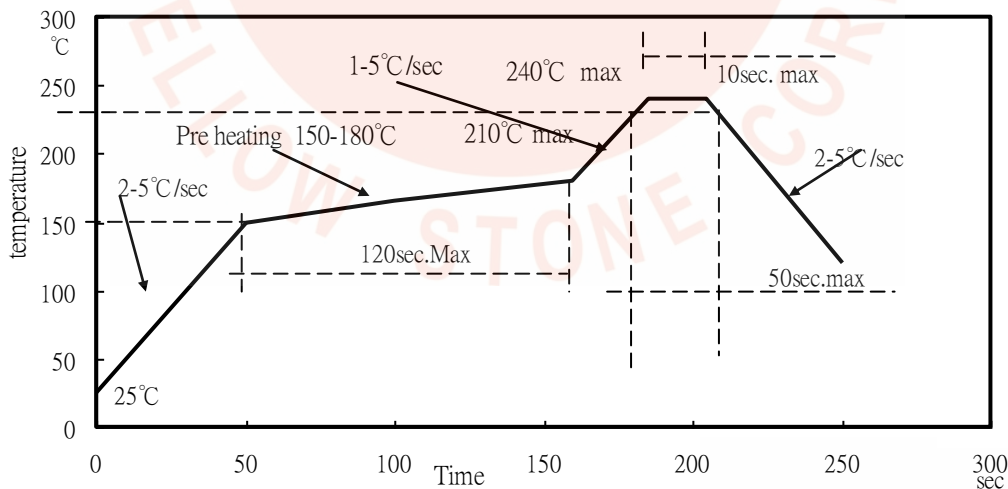

#### NOTES:

1. We recommend the reflow temperature  $240^{\circ}\text{C} (\pm 5^{\circ}\text{C})$ . the maximum soldering temperature should be limited to  $260^{\circ}\text{C}$ .
2. Don't cause stress to the silicone resin while it is exposed to high temperature.
3. Number of reflow process shall be 1 time.

## Test circuit and handling precautions

### ■ Test circuit

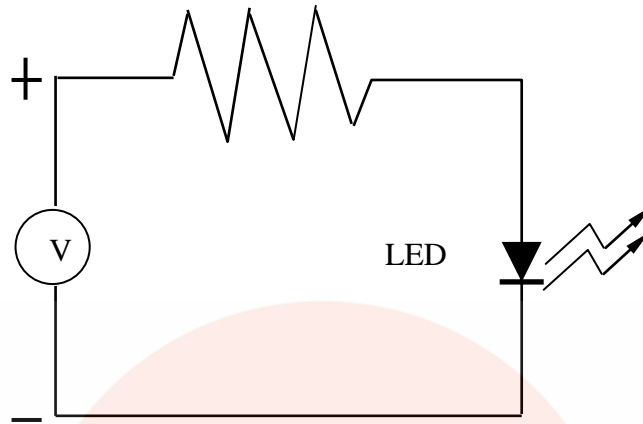

### ■ Handling precautions

#### 1. Over-current-proof

Customer must apply resistors for protection; otherwise slight voltage shift will cause big current change (Burn out will happen).

#### 2.Storage

2.1 It is recommended to store the products in the following conditions:

Humidity: 60% R.H. Max.

Temperature : 5°C~30°C (41°F~86°F)

2.2 Shelf life in sealed bag: 12 month at <5°C~30°C and <60% R.H. after the package is

Opened, the products should be used within a week or they should be keeping to stored at  $\leq 20\%R.H.$  with zip-lock sealed.

#### 3.Baking

It is recommended to baking before soldering when the pack is unsealed after 24hrs. The

Conditions are as followings:

3.1 70±3°C x 24hrs and <5%RH, taped reel type

3.2 100±3°C x 2hrs , bulk type

3.3 130±3°C x(15~30min), bulk type

It shall be normal to see slight color fading of carrier(light yellow) after baking in process

## Packing-1

### 3528 Single-Color High Performance SMD Top LEDs Packaging Specifications

- Feeding Direction

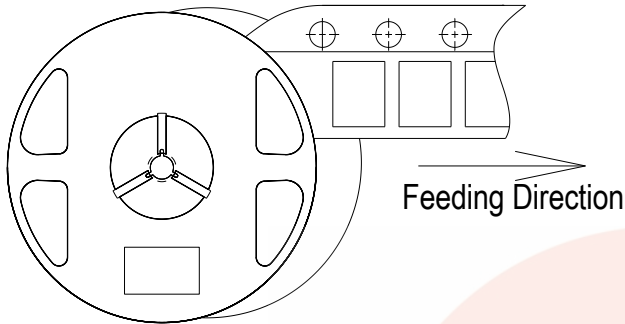

- Dimensions of Reel (Unit: mm)

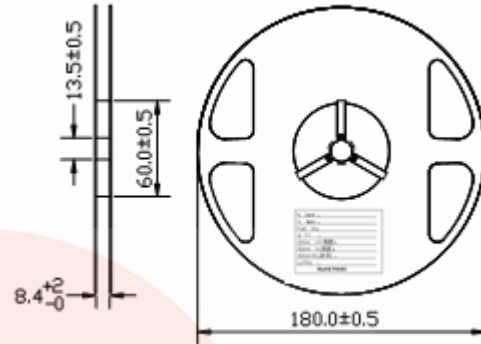

- Dimensions of Tape (Unit: mm)

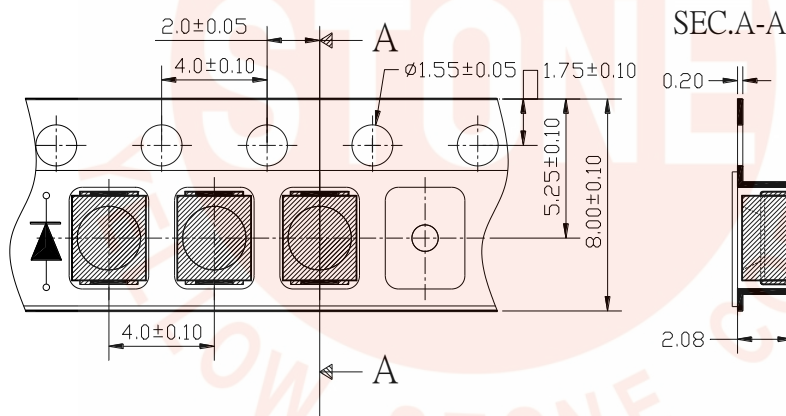

- Arrangement of Tape

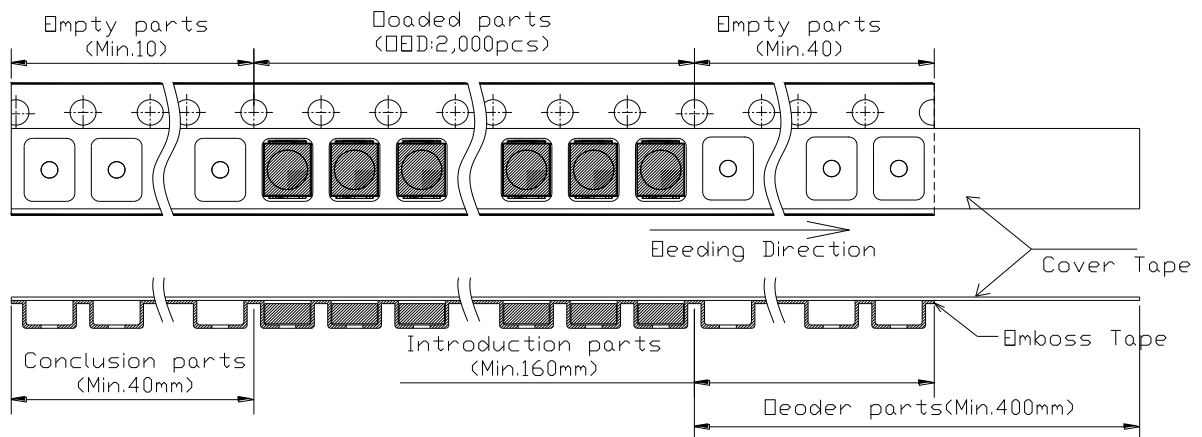

#### NOTES

1. Empty component pockets are sealed with top cover tape;
2. The maximum number of missing smds is two;
3. The cathode is oriented towards the tape sprocket hole in accordance with ANSI/EIA RS-481 specifications;
4. 2,000pcs/Reel



## 3528 Single-Color High Performance SMD Top LEDs Packaging Specifications

### ● Packaging specifications

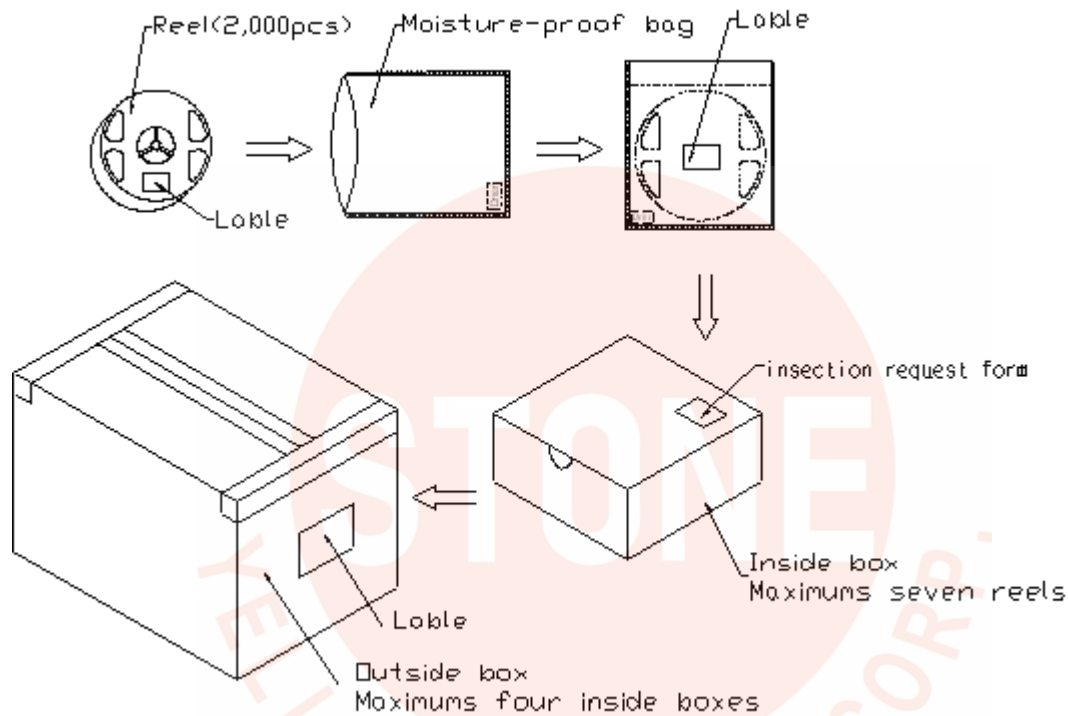

#### NOTES:

Reeled products (The most numbers of products are 2,000pcs) packed in a seal off moisture-proof bag along with a desiccant one by one, Seven moisture-proof bag of maximums (total maximum number of products are 14,000pcs) packed in an inside box (size: about 238mm x about 194mm x about 102mm) and four inside boxes of maximums are put in the outside box (size: about 410mm x about 254mm x about 229mm) Together with buffer material, and it is packed. (Part No., Lot No., quantity should appear on the label on the moisture-proof bag, part No. And quantity should appear on the in section request form on the cardboard box.) .

## Precautions

### 1、Abnormal situation caused by improper setting of collet

To choose the right collet is the key issue in improving the product's quality. LED is different from other electronic components, which is not only about electrical output but also for optical output. This characteristic made LED more fragile in the process of SMT. If the collet's lowering down height is not well set, it will bring damage to the gold wire at the time of collet's picking up and loading which will cause the LED fail to light up, light up now and then or other quality problems

### 2、How to choose the collet

During SMT, please choose the collet that has larger outer diameter than the lighting area of lens, in case that improper position of collet will damage the gold wire inside the LED. Different collets fit for different products, please refer to the following pictures cross out:

Outer diameter of collet should be larger than the lighting area

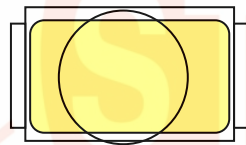

Picture 1 (√)

Outer diameter of collet

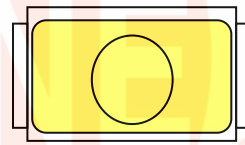

Picture 2 (×)

### 3、How to set the height of collet

The reason why for top view SMD, the height of collet before it presses downward will directly affect the quality of products during SMT is that if the collect go down too much, it will press lens and cause the distortion or breaking of gold wire. The setting of collet position should follow the pictures belowed.

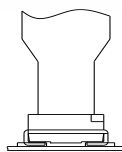

Picture 3 (√)

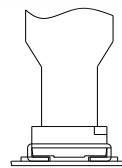

Picture 4 (×)

### No.3、Other points for attention

- A、No pressure should be exerted to the epoxy shell of the SMD under high temperature.
- B、Do not scratch or wipe the lens since the lens and gold wire inside are rather fragile and cross out easy to break.
- C、LED should be used as soon as possible when being taken out of the original package, and should be stored in anti-moisture and anti-ESD package.

### No.4、This usage and handling instruction is only for your reference.

## Test items and results of reliability

Type	Test Item	Test Standard	Test Conditions	Note	Number of Damaged
Environmental Sequence	Temperature Cycle	JEITA ED-4701 300 303	-40°C 30min ↑↓5 min 100°C 30min	100 cycle	0/50
	Thermal Shock	JEITA ED-4701 200 303	-10°C 15min ↑↓5sec 100°C 15min	20 cycle	0/22
	High Temperature Storage	JEITA ED-4701 200 201	T <sub>a</sub> =100°C	1000 hrs	0/22
	Humidity Heat Storage	JEITA ED-4701 100 103	T <sub>a</sub> =60°C RH=90%	1000 hrs	0/22
	Low Temperature Storage	JEITA ED-4701 200 202	T <sub>a</sub> =-40°C	1000 hrs	0/22
Operation Sequence	Life Test	Tested with Brightek standard	T <sub>a</sub> =25°C I <sub>F</sub> =20mA	1000 hrs	0/22
	High Humidity Heat Life Test	Tested with Brightek standard	60°C RH=90% I <sub>F</sub> =15mA	500 hrs	0/22
	Low Temperature Life Test	Tested with Brightek standard	T <sub>a</sub> =-20°C I <sub>F</sub> =20mA	1000 hrs	0/22

## Judgment criteria of failure for the reliability

Measuring items	Symbol	Measuring conditions	Judgement criteria for failure
Forward voltage	V <sub>f</sub> (V)	I <sub>F</sub> =20mA	Over U <sub>x</sub> 1.2
Reverse current	I <sub>R</sub> (uA)	V <sub>r</sub> =5V	Over U <sub>x</sub> 2