



Customer Part No.:

Brightek Part No.: 1SC5050VGB00MG02

Specification.: TD0120A20H04000

Documents No.: BT-50-1005002

Prepared By: Huanhuan. Yi

Checke By:

Time: 2012/04/14

Customer Confirmation:

Features

- § 5.0mmx5.0mm SMT LED , 1.6mm Thickness.
- § Low Power Consumption.
- § Viewing Angle 120°.
- § Various Colors And Types Available.
- § Package: 1000 PCS/Reel.
- § Resin(Mold): Silicone
- § Dice: Red (AlGaInP) 、 Green (InGaN) 、 Blue 、 (InGaN)
- § Pulsed Forward Current 100 mA※(Duty 1/10, Pulse Width 0.1ms.)
- § Reverse Voltage:5 V
- § Operating Temperature: -40~ +80°C
- § Storage Temperature: -40 ~ +100°C
- § Soldering Temperature: 260for5sec°C

Catalog

Electrical-Optical Characteristics.....	2
Intensity Bin Limit	3
Optical Characteristics	4-7
Outline Dimensions	8
Reflow Profile	9
Test items and results of reliability	10
Packing	11-12
Test circuit and handling precautions	13
LED Usage and Handling Instructions	14-15

Electrical-Optical Characteristics (Ta=25°C)

Parameter	Symbol		Value			Unit	Test condition
			Min.	Typ.	Max.		
Forward Voltage	Vf	R	1.7	1.9	2.6	V	If=20mA
		G	2.8	3.2	3.8	V	If=20mA
		B	2.8	3.2	3.8	V	If=20mA
Luminous intensity	Iv	R	430	620	...	mcd	If=20mA
		G	1120	1500	...	mcd	If=20mA
		B	260	260	...	mcd	If=20mA
Wavelength	λ d	R	620	...	635	(nm)	If=20mA
		G	520	...	535	(nm)	If=20mA
		B	461	...	476	(nm)	If=20mA
Reverse Current	Ir		10	μ A	Vr=5V
Viewing angle	2θ 1/2		...	120	...	Deg	If=20mA
Junction Temperature	Tj		110	°C	If=20mA
Electrostatic Discharge Classification	ESD		1000V				

- 1.Luminous intensity (IV) ±10%, Forward Voltage (VF) ±0.1V, Wavelength(λ d) ±0.5nm
- 2.IS standard testing
3. Junction Temperature R=G=B=110°C
4. Electrostatic Discharge Classification R=G=B=1000V

Product Identification Code

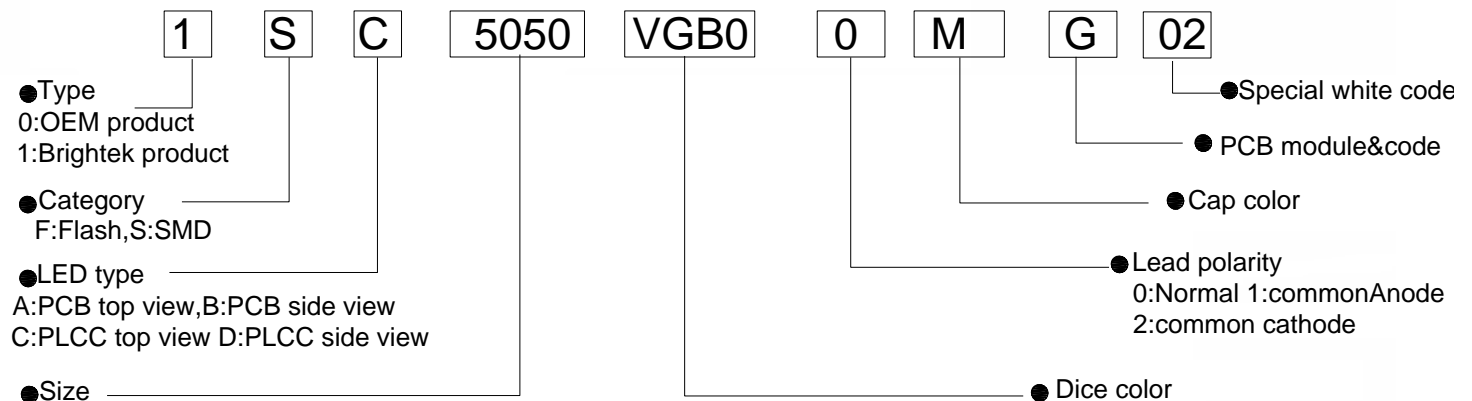



INTENSITY BIN LIMIT (IF = 20 mA)

Red		
Bin Code	Min. (mcd)	Max. (mcd)
11	430	540
12	540	675
13	675	845

Green		
Bin Code	Min. (mcd)	Max. (mcd)
12	1120	1400
13	1400	1700
14	1700	2120

Blue		
Bin Code	Min. (mcd)	Max. (mcd)
11	260	325
12	325	405
13	405	505

※ Tolerance of measurement of luminous intensity is $\pm 10\%$.

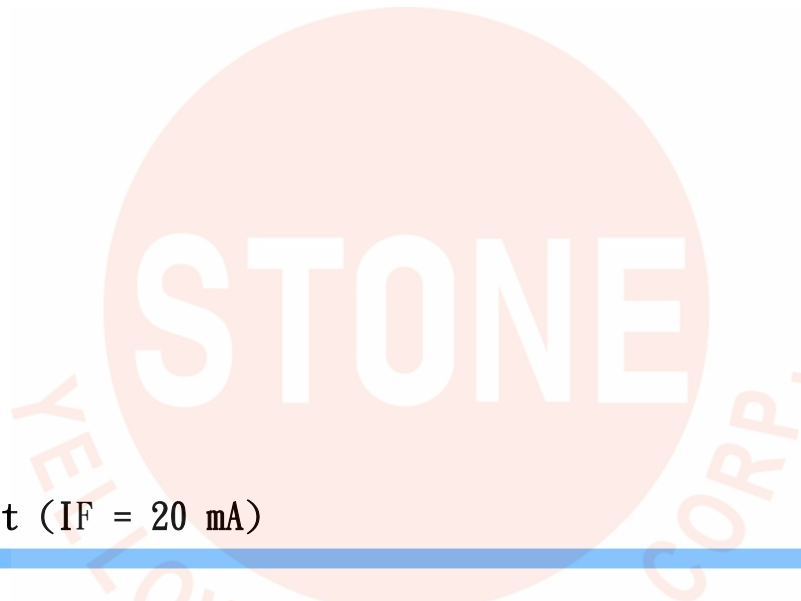

Color Bin Limit (IF = 20 mA)

Red		
Bin Code	Min. (nm)	Max. (nm)
1	620	625
2	625	630
3	630	635

Green		
Bin Code	Min. (nm)	Max. (nm)
2	520	525
3	525	530
4	530	535

Blue		
Bin Code	Min. (nm)	Max. (nm)
2	461	466
3	466	471
4	471	476

※ Tolerance of measurement of dominant wavelength is ± 1 nm.

◆ Please check sorting method, We will amend the Bin code to maintain Bin Code centralize .



Relative Spectral Power Distribution(Ta=25°C)

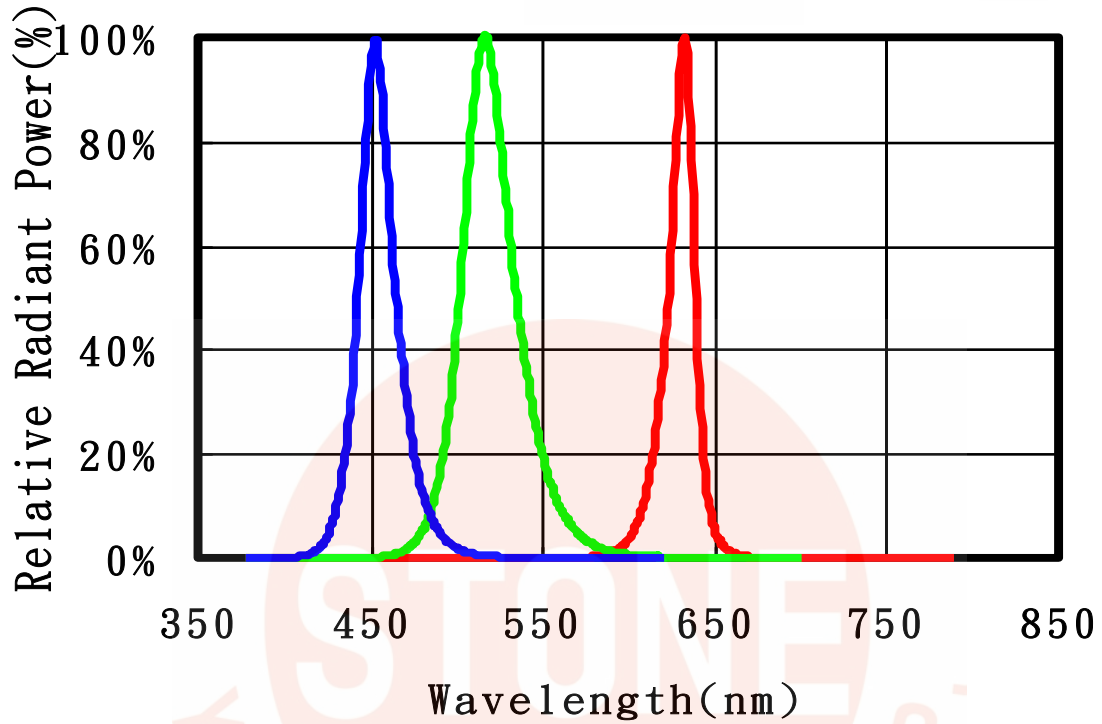

Typical Spatial Distribution

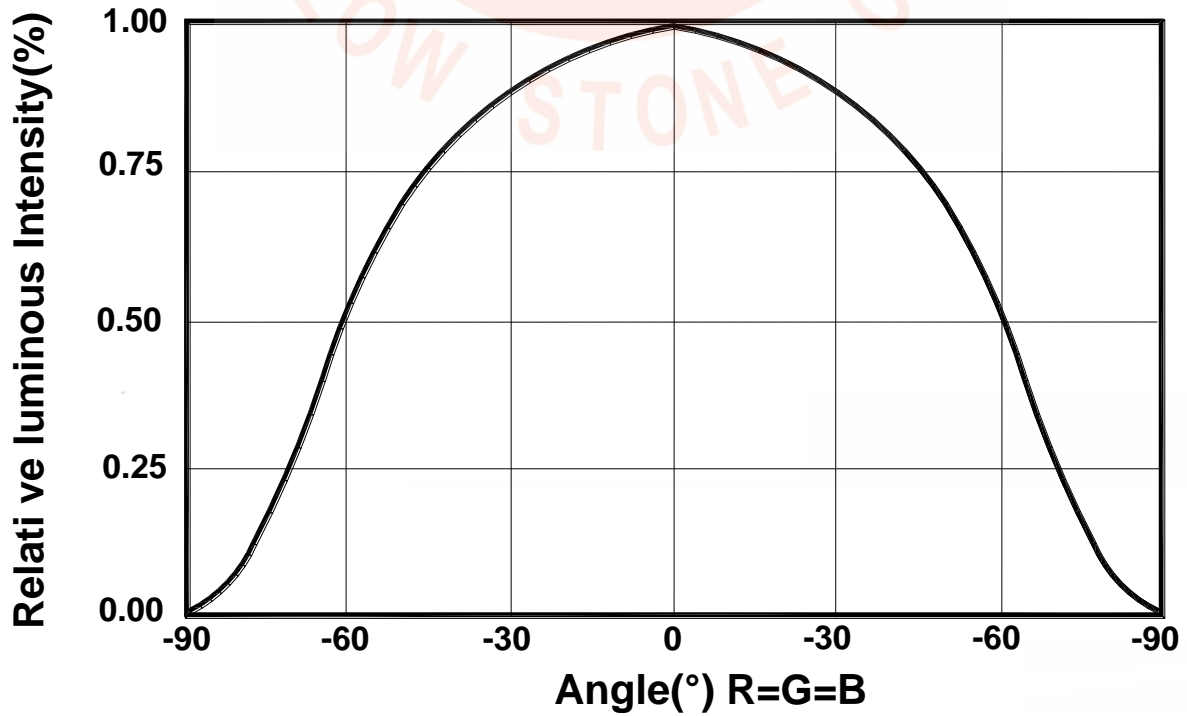



Relative Flux vs. Current (Ta=25°C)

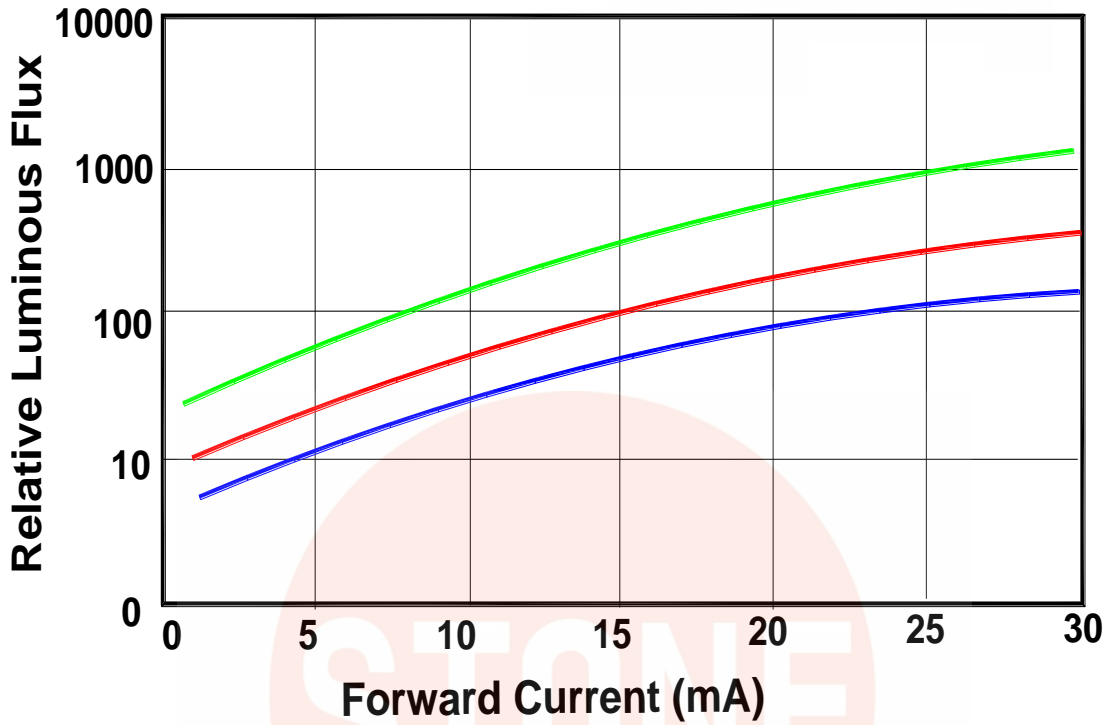

Relative Flux vs. Ambient Temperature

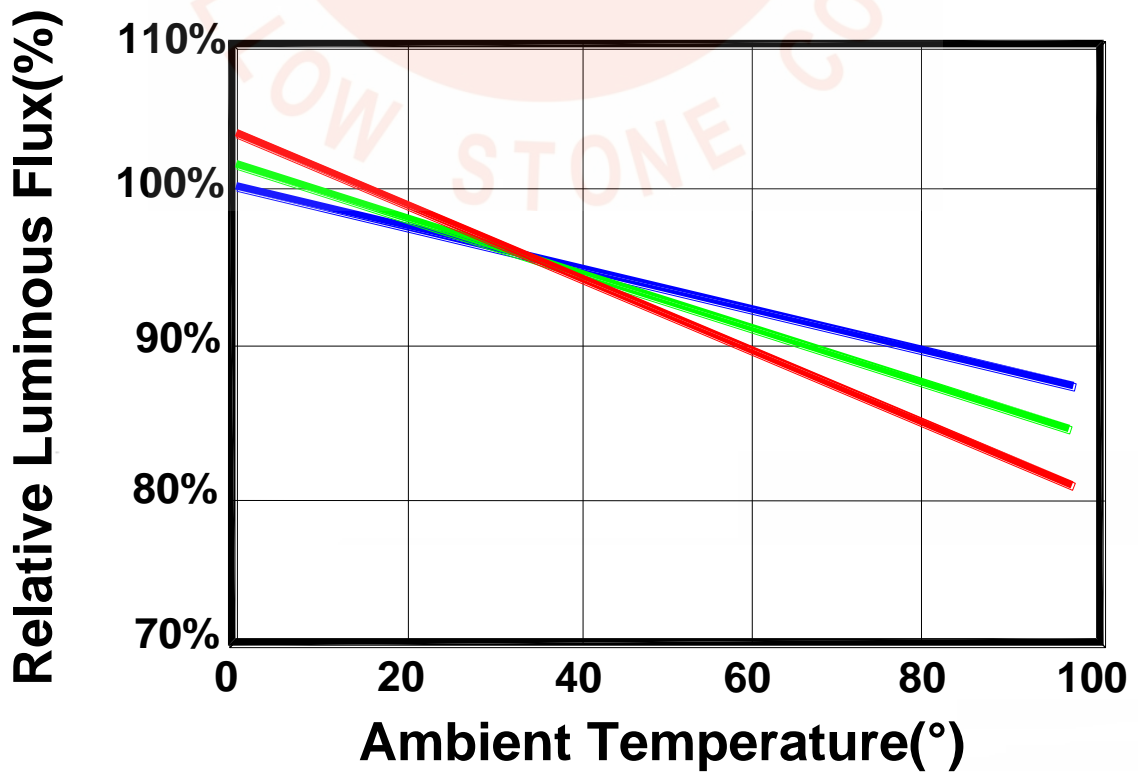



Forward Voltage .Ambient Temperature

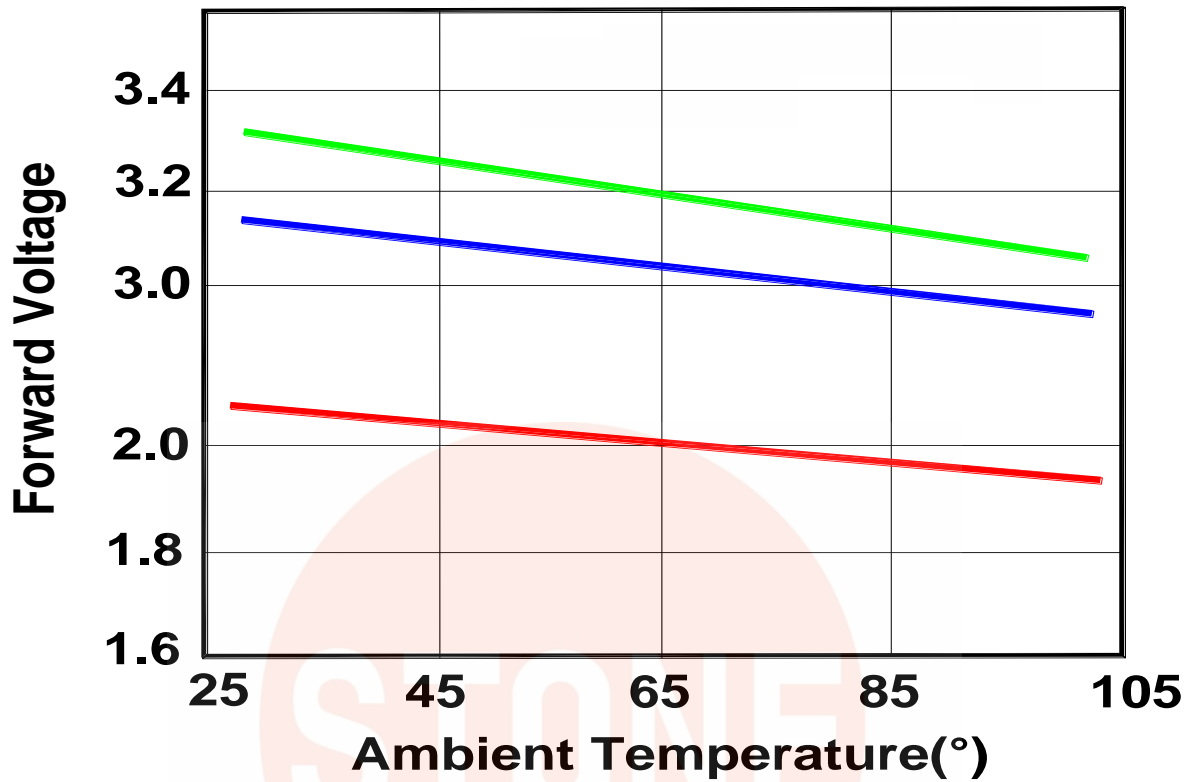

Electrical Characteristics °C)

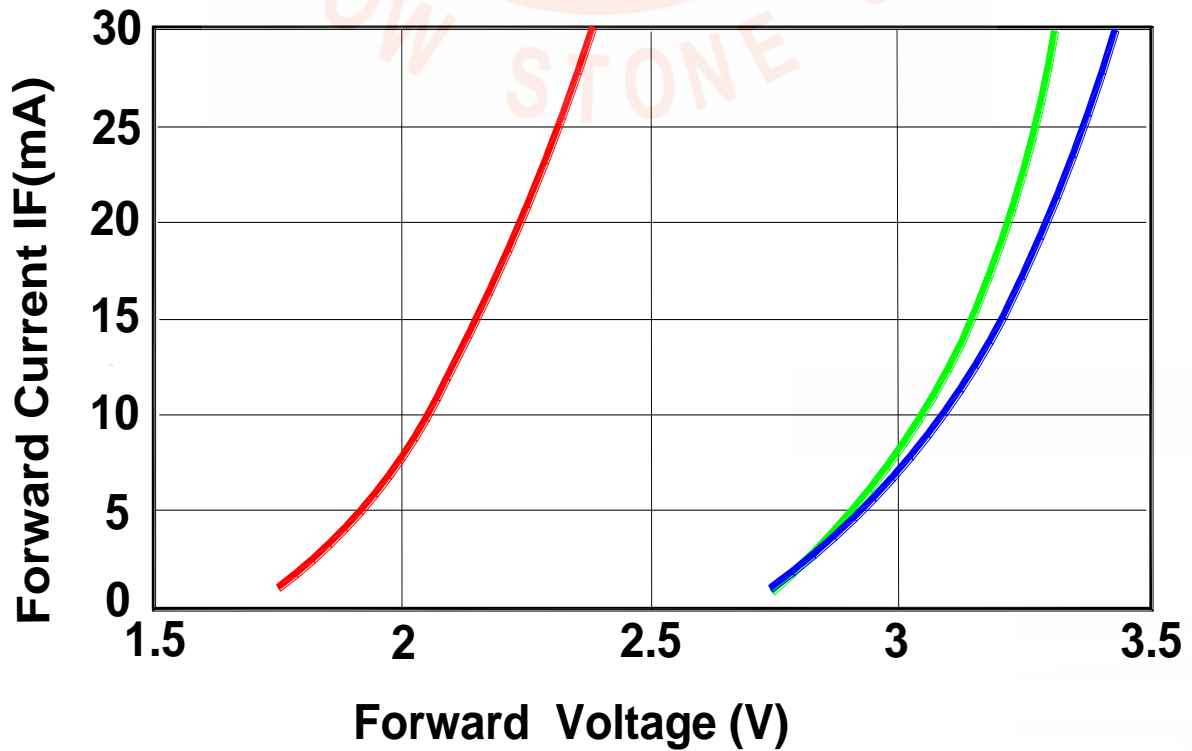



Chromaticity Coordinates .Forward Current

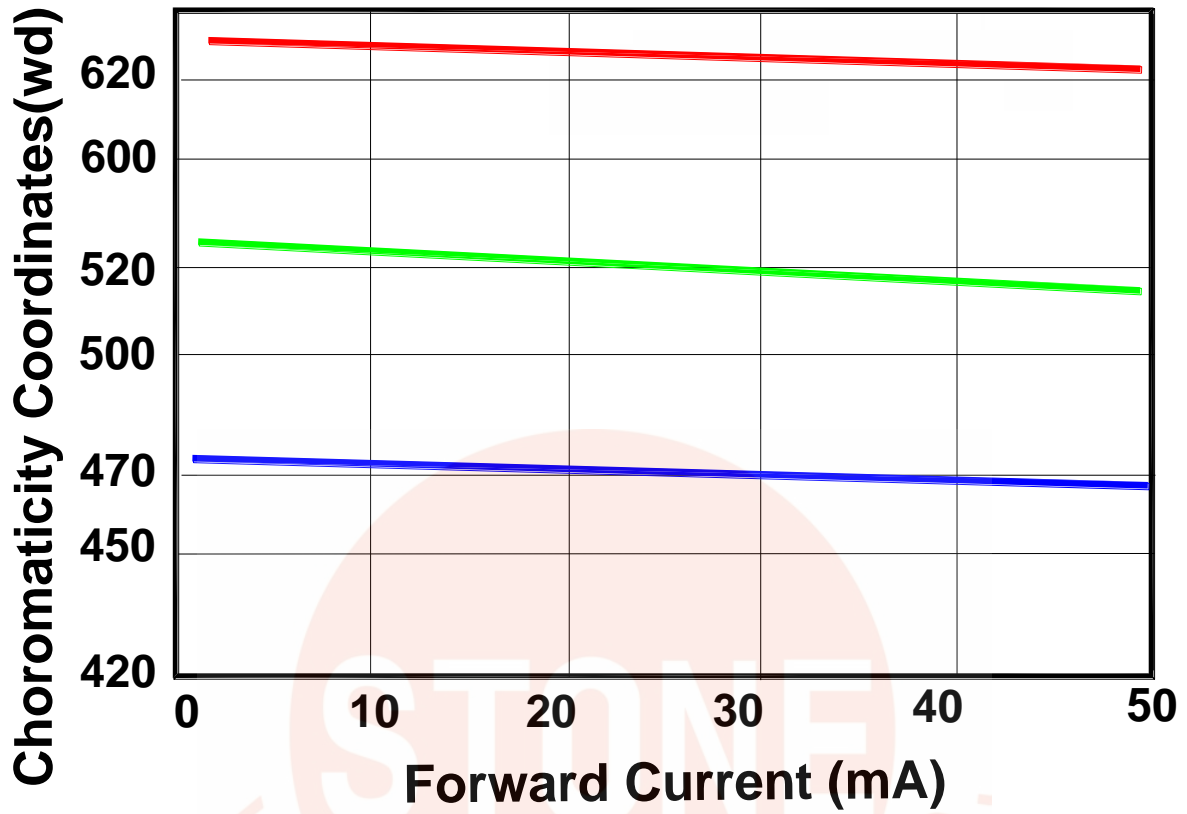

Thermal Design

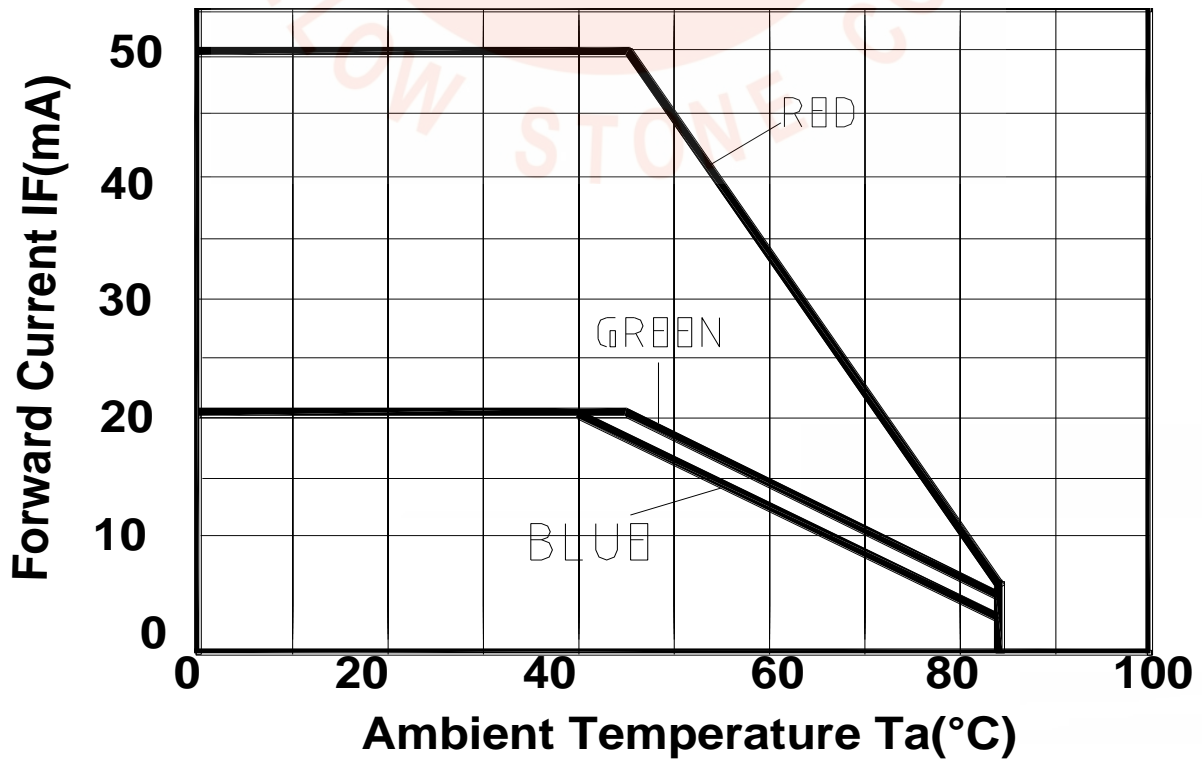

Outline Dimensions

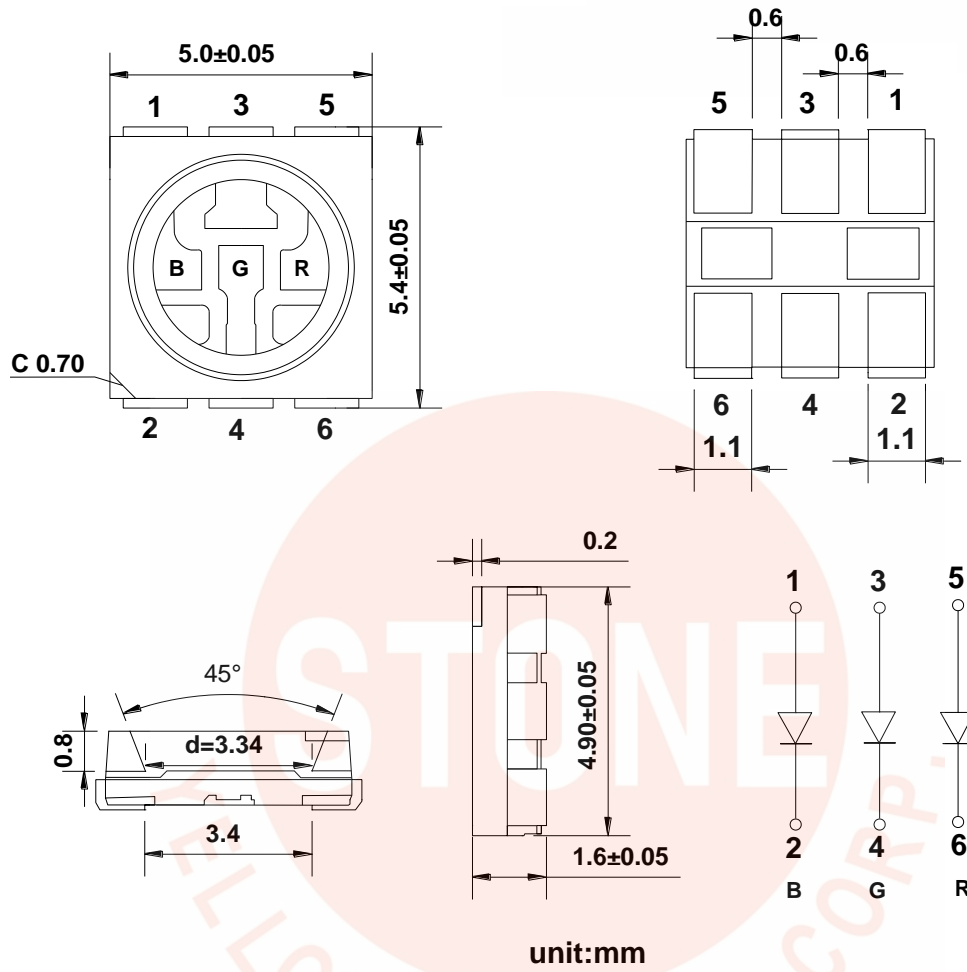

RECOMMEND PADLAYOUT

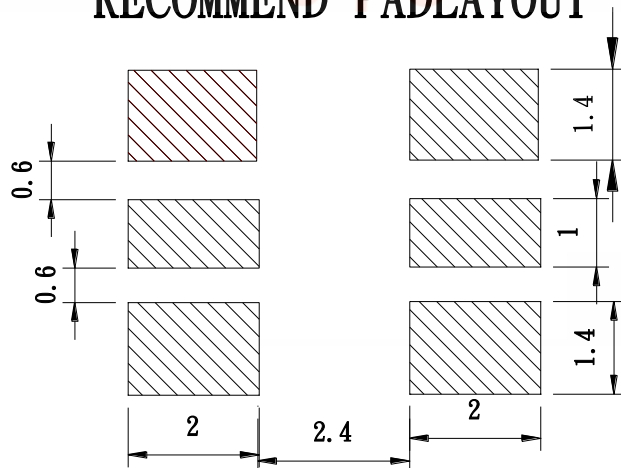

- § All dimensions are in millimeters.
- § Tolerance is ± 0.1 mm unless other specified
- § Specifications are subject to change without notice.

Reflow Profile

■ Reflow Temp/Time

IR reflow soldering Profile

Lead Free solder

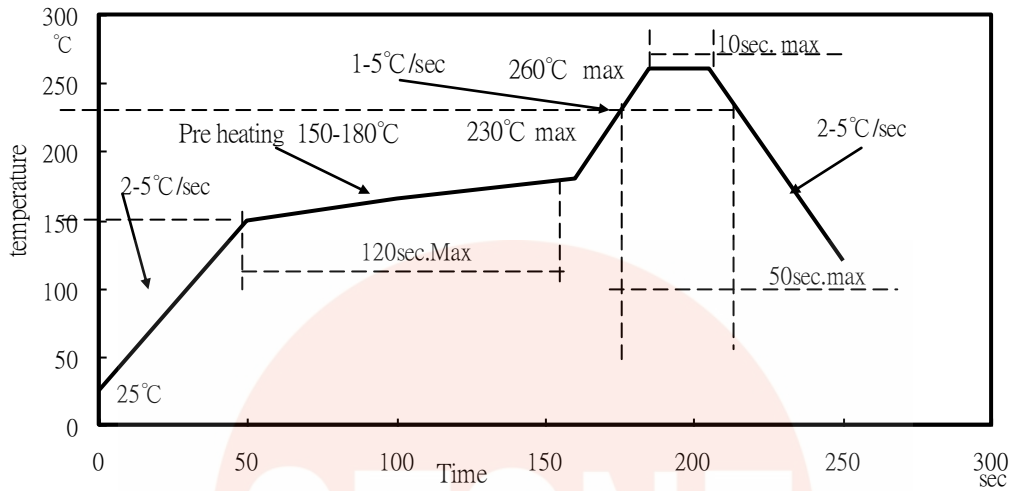

IR reflow soldering Profile

Lead solder

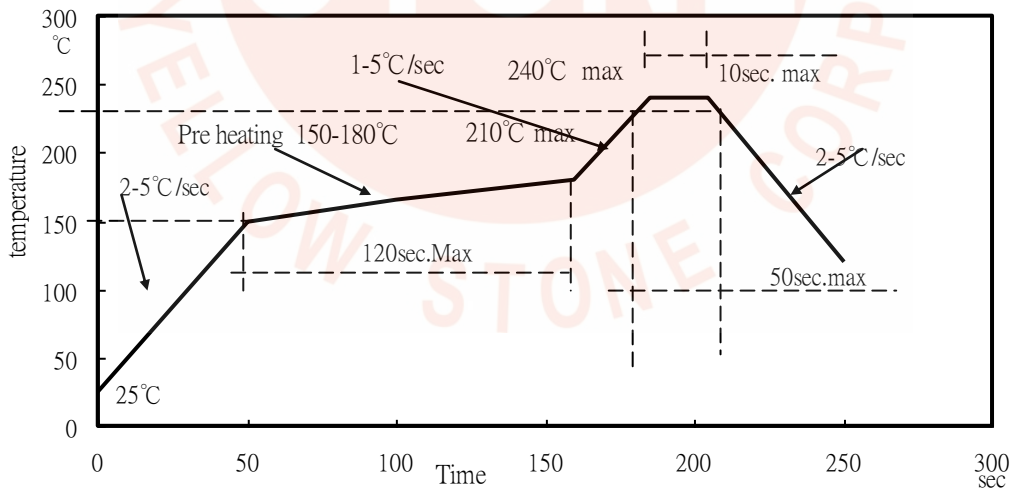

NOTES:

1. We recommend the reflow temperature $240^{\circ}\text{C} (\pm 5^{\circ}\text{C})$. the maximum soldering temperature should be limited to 260°C .
2. Don't cause stress to the silicone resin while it is exposed to high temperature.
3. Number of reflow process shall be 1 time.

Test items and results of reliability

Test Item	Test Conditions	Duration/ Cycle	Number of Damage	Reference
Temperature Cycle	-40°C 30min ↑ ↓ 25°C (5 min) 100°C 30min	100 cycle	0/22	JEITA ED-4701 300 303
Thermal Shock	-40°C 30min ↑ ↓ 5sec 110°C 30min	100 cycle	0/22	JEITA ED-4701 200 303
High Temperature Storage	T _a =100°C	1000 hrs	0/22	EIAJED-4701 200 201
Humidity Heat Storage	T _a =85°C RH=85%	1000 hrs	0/22	EIAJED-4701 100 103
Low Temperature Storage	T _a =-40°C	1000 hrs	0/22	EIAJED-4701 200 202
Life Test	T _a =25°C IF=20mA	1000 hrs	0/22	Tested with Brightek standard
High Humidity Heat Life Test	60°C RH=90% IF=20mA	1000 hrs	0/22	Tested with Brightek standard
Low Temperature Life Test	T _a =-40°C IF=20mA	1000 hrs	0/22	Tested with Brightek standard
ESD(HBM)	1KV at 1.5kΩ;100pf	3 Time	0/22	MIL-STD-883D

*Criteria for Judging the Damage

Item	Symbol	Condition	Criteria for Judgement	
			MIN	MAX
Forward Voltage	VF	IF=20mA	—	USL* ¹ ×1.1
Reverse Current	IR	VR=5V	—	10μA
Luminous Intensity	Iv	IF=20mA	LSL* ² ×0.7	—

[Note]*¹USL:Upper Specification Level

*² LSL: Lower Specification Level

Packing

5050 Full-Color High Performance SMD Top LEDs Packaging Specifications

● Dimensions of Reel (Unit: mm)

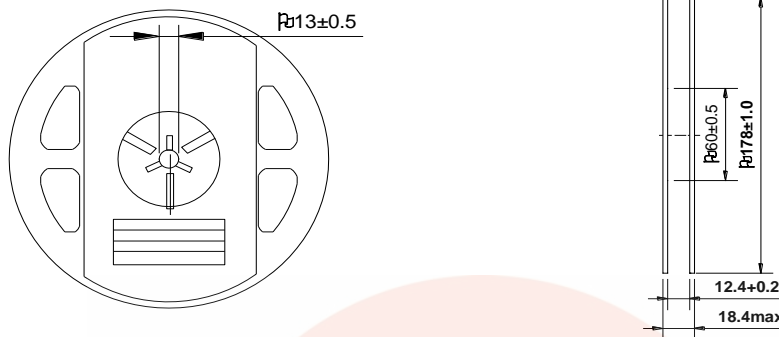

Note: 01.The tolerance unless mentioned is ± 0.1 mm.
 02.The measured unit is "mm".

● Dimensions of Tape (Unit: mm)

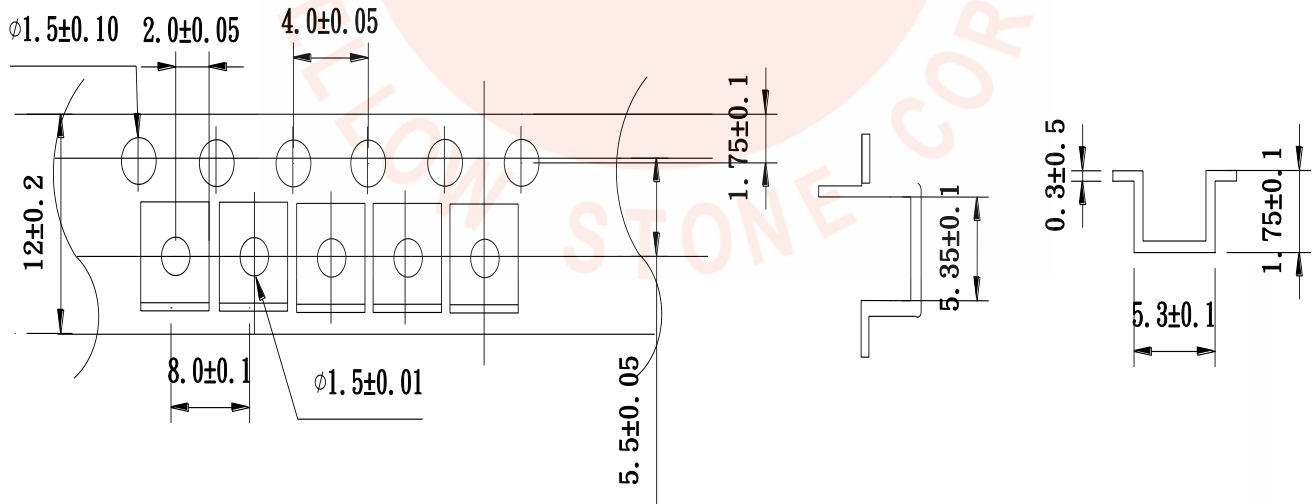

NOTES

1. Empty component pockets are sealed with top cover tape;
2. The maximum number of missing SMDs is two;
3. The cathode is oriented towards the tape sprocket hole in accordance with ANSI/EIA RS-481 specifications;
4. 1,000pcs/Reel

5050 Full-Color High Performance SMD Top LEDs Packaging Specifications

- Packaging specifications

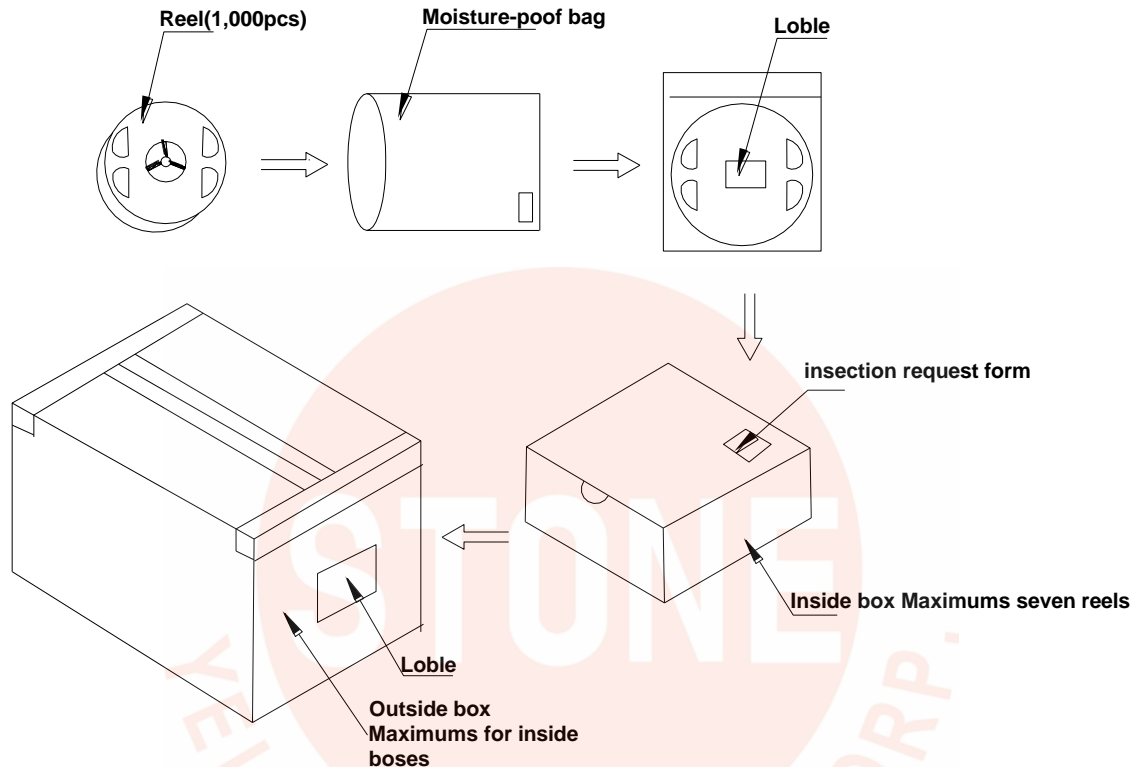

NOTES:

Reeled products (The most numbers of products are 1,000 pcs) packed in a seal off moisture-proof bag along with a desiccant one by one, Five moisture-proof bag of maximums (total maximum number of products are 5,000 pcs) packed in an inside box (size: about 238mm x about 194mm x about 102mm) and four inside boxes of maximums are put in the outside box (size: about 410mm x about 254mm x about 229mm) Together with buffer material, and it is packed. (Part No., Lot No., quantity should appear on the label on the moisture-proof bag, part No. And quantity should appear on the in section request form on the cardboard box.) .

Test circuit and handling precautions

■ Test circuit

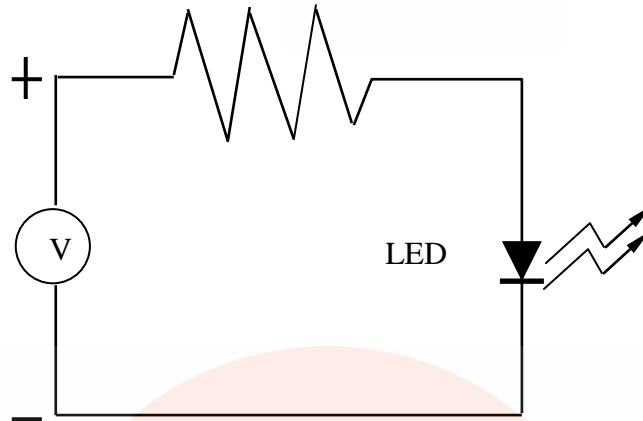

■ Handling precautions

1. Over-current-proof

Customer must apply resistors for protection; otherwise slight voltage shift will cause big current change (Burn out will happen).

2.Storage

2.1 It is recommended to store the products in the following conditions:

Humidity: 60% R.H. Max.

Temperature : $5^{\circ}\text{C} \sim 30^{\circ}\text{C}$ ($41^{\circ}\text{F} \sim 86^{\circ}\text{F}$)

2.2 Shelf life in sealed bag: 12 month at $< 5^{\circ}\text{C} \sim 30^{\circ}\text{C}$ and $< 60\%$ R.H. after the package is Opened, the products should be used within a week or they should be keeping to stored at $\leq 20\%$ R.H. with zip-lock sealed.

3.Baking

It is recommended to baking before soldering when the pack is unsealed after 24hrs. The Conditions are as followings:

3.1 $70 \pm 3^{\circ}\text{C}$ x 24hrs and $< 5\%$ RH, taped reel type

3.2 $100 \pm 3^{\circ}\text{C}$ x 2hrs , bulk type

3.3 $130 \pm 3^{\circ}\text{C}$ x(15~30min), bulk type

LED Usage and Handling Instructions

No.1 、soldering

A 、It is not better to be manual soldering

B 、Reflow soldering :

1 、Soldering according to the following temperature chart is highly recommended

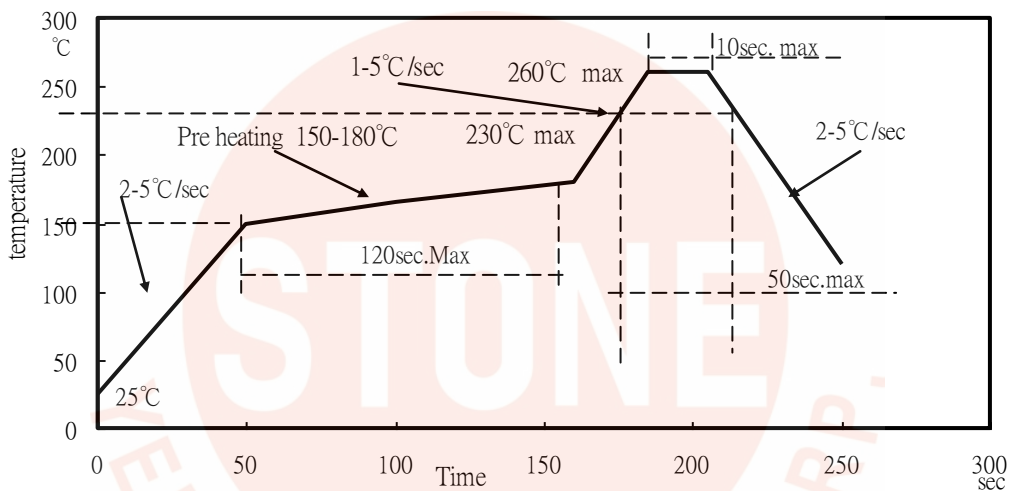

2 、Soldering paste

Use soldering paste with the melting point at 230°C is recommended

No.2 、Collet

(1) 、Abnormal situation caused by improper setting of collet

To choose the right collet is the key issue in improving the product's quality. LED is different from other electronic components, which is not only about electrical output but also for optical output. This characteristic made LED more fragile in the process of SMT. If the collet's lowering down height is not well set, it will bring damage to the gold wire at the time of collet's picking up and loading which will cause the LED fail to light up, light up now and then or other quality problems

(2) 、How to choose the collet

During SMT, please choose the collet that has larger outer diameter than the lighting area of lens, in case that improper position of collet will damage the gold wire inside the LED. Different collets fit for different products, please refer to the following pictures cross out:.

Outer diameter of collet should be larger than the lighting area

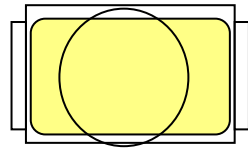

Picture 1 (✓)

Outer diameter of collet

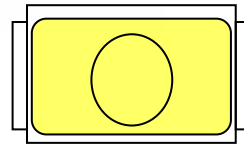

Picture 2 (×)

3、How to set the height of collet

The reason why for top view SMD, the height of collet before it presses downward will directly affect the quality of products during SMT is that if the collect go down too much, it will press lens and cause the distortion or breaking of gold wire. The setting of collet position should follow the pictures belowed.

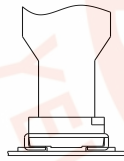

Picture 3 (✓)

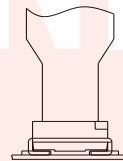

Picture 4 (×)

No.3、 Other points for attention

- A、 No pressure should be exerted to the epoxy shell of the SMD under high temperature.
- B、 Do not scratch or wipe the lens since the lens and gold wire inside are rather fragile and cross out easy to break.
- C、 LED should be used as soon as possible when being taken out of the original package, and should be stored in anti-moisture and anti-ESD package.

No.4、 This usage and handling instruction is only for your reference.