

**COMMODITY: SURFACE MOUNT LED SMD SPECIFICATION**

**Part No: 1TC5003Y24H2CF01**

**Characters**

- § 5.0mm×5.0mm SMT LED , 1.5mm THICKNESS.
- § LOW POWER CONSUMPTION.
- § VIEWING ANGLE 120°.
- § VARIOUS COLORS AND LENS TYPES AVAILABLE.
- § PACKAGE: 1000 PCS/REEL.

ITEM	MATERIALS
Resin(Mold)	Silicon
Lens Color	Water Transparent
Dice	AlGaInP
Emitted color	Yellow

**Absolute Maximum Ratings (Ta=25°C)**

Item	Symbol	Value	Unit
Power Dissipation/DICE	PD	120*3	mW
DC Forward Current/DICE	IF	30*3	mA
Single chip Pulsed Forward Current	IFP	100※	mA
Reverse Voltage	VR	5	V
Operating Temperature	Topr	-30 ~ +80■	°C
Storage Temperature	Tstg	-40 ~ +100	°C
Soldering Temperature	Tsol	260for5sec△	°C

※Duty 1/10, Pulse Width 0.1ms.

△Soldering time max 10sec Diode

■please refer to IF-Ta diagram of curves for the temperature during application

### Electrical-Optical Characteristics (Ta=25°C)

Parameter	Symbol	Value			Unit	Test condition
		Min.	Typ.	Max.		
Forward Voltage	V <sub>f</sub>	1.7	2.0	2.4	V	I <sub>f</sub> =20mA*3
Luminous intensity	I <sub>v</sub>	1300	1900	---	mcd	I <sub>f</sub> =20mA*3
Wavelength	X	585		597	---	I <sub>f</sub> =20mA*3
Reverse Current	I <sub>r</sub>	---	---	10	μ A	V <sub>r</sub> =5V
Viewing angle	2θ 1/2	---	120	---	Deg	I <sub>f</sub> =20mA*3

- ▲ 1.Luminous intensity (IV) ±10%, Forward Voltage(VF) ±0.1V, Wavelength(λ d) ±0.5nm  
 2.IS standard testing

### Range of bins

<b>Bin</b>	Bin1-a	Bin1-b	Bin1-c	Bin1-d	Bin1-e	Bin2	Bin3
<b>Iv(mcd)</b>	3-6	6-9	9-13	13-20	20-30	30-40	40-55
<b>Bin</b>	Bin4	Bin5	Bin6	Bin7	Bin8	Bin9	Bin10
<b>Iv(mcd)</b>	55-70	70-90	90-120	120-160	160-210	210-270	270-350
<b>Bin</b>	Bin11	Bin12	Bin13	Bin14	Bin15	Bin16	Bin17
<b>Iv(mcd)</b>	350-460	460-600	600-780	780-1000	1000-1300	1300-1700	1700-2200
<b>Bin</b>	Bin18	Bin19	Bin20	Bin21	Bin22	Bin23	Bin24
<b>Iv(mcd)</b>	2200-2800	2800-3600	3600-4600	4600-6000	6000-7800	7800-10100	10100-13130
<b>Bin</b>	Bin25	Bin26					
<b>Iv(mcd)</b>	13130-17000	17000-22100					
<b>Bin</b>	<b>C</b>	<b>D</b>	<b>E</b>	<b>F</b>			
<b>WL(nm)</b>	<b>585-588</b>	<b>588-591</b>	<b>591-594</b>	<b>594-597</b>			

### Outline Dimensions

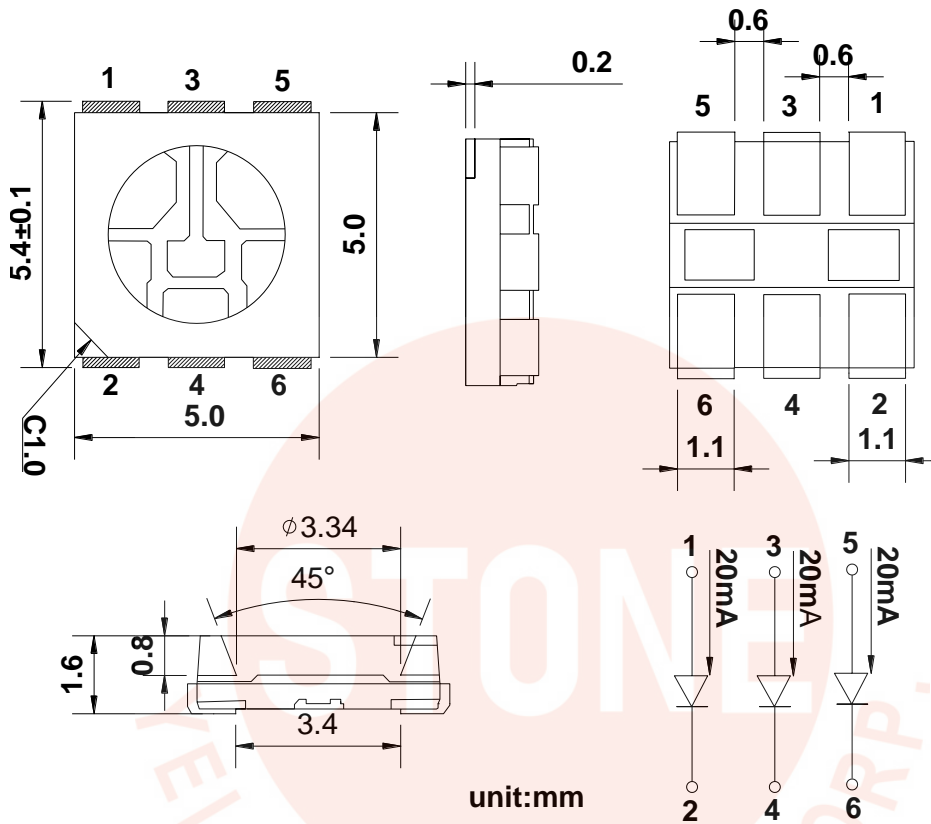

#### RECOMMEND PADLAYOUT

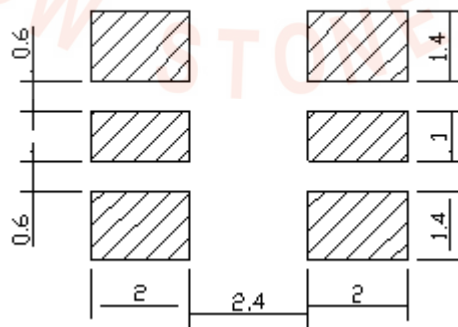

- § All dimensions are in millimeters.
- § Tolerance is  $\pm 0.1$  mm unless other specified
- § Specifications are subject to change without notice.

**COMMODITY: SURFACE MOUNT CHIP LED SMD SPECIFICATION**

**DEVICE NUMBER: 1TC5003Y24H2CF01**

Fig.1 IF-VF(Ta=25°C)

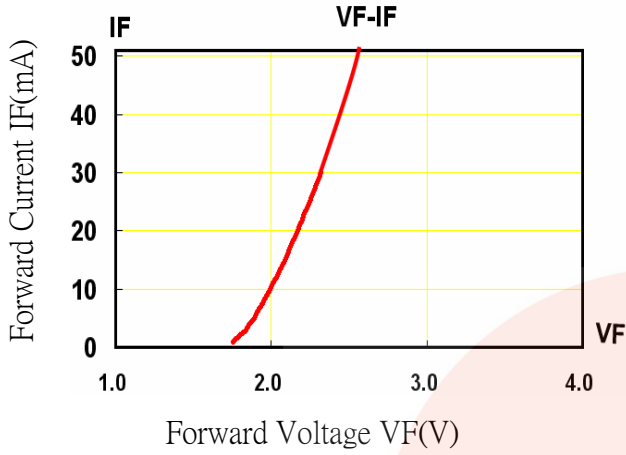

Fig.2 Relative Luminous Intensity-IF(Ta=25°C)

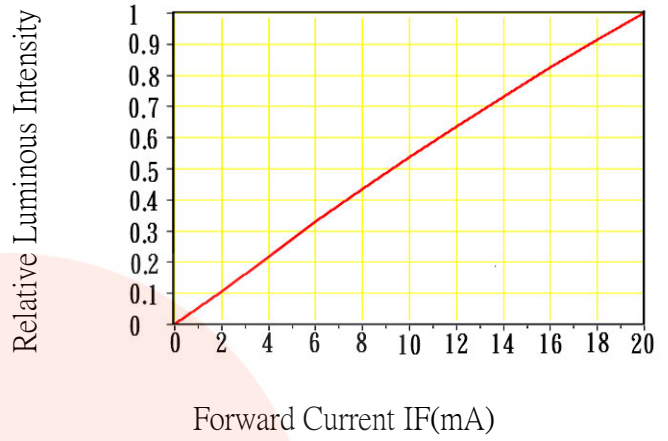

Fig.3 Wavelength Characteristics (Ta=25°C)

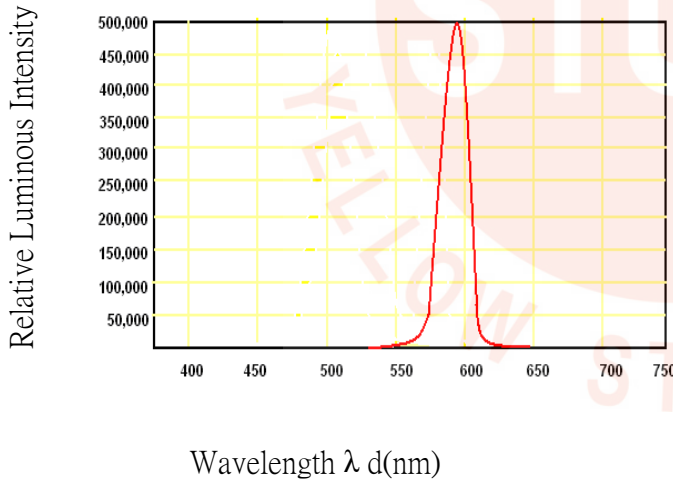

Fig.4 Relative Luminous Intensity-Ta

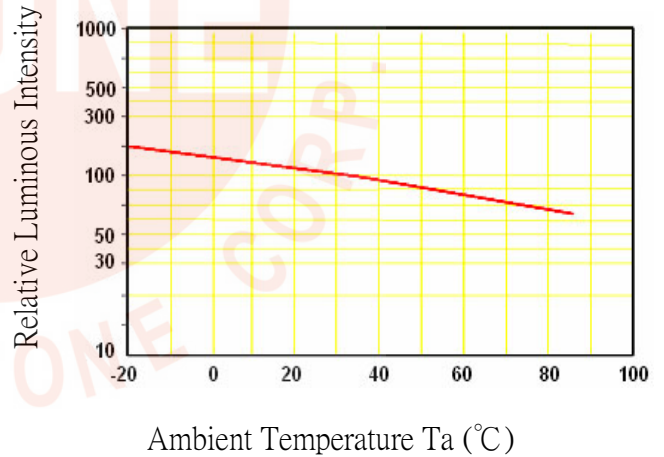
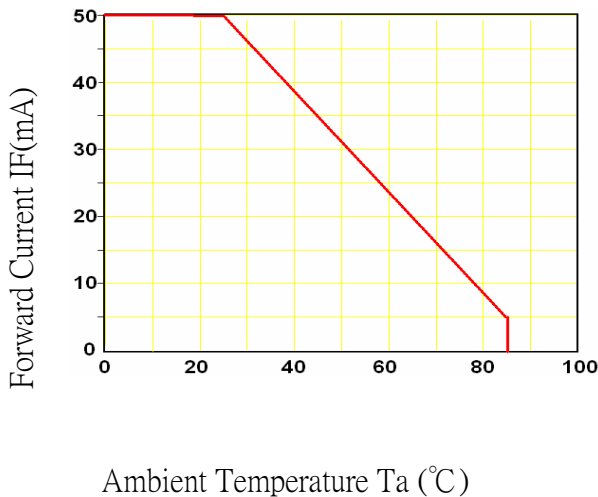
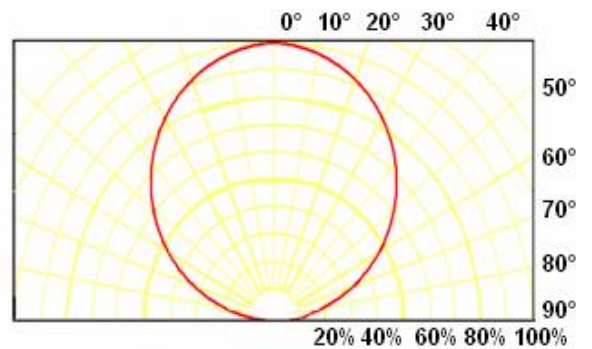

Fig.5 IF-Ta



Directive Characteristics (Ta=25°C)



## Reflow Profile

### ■ Reflow Temp/Time

**IR Reflow Soldering Profile  
Lead Free Solder**

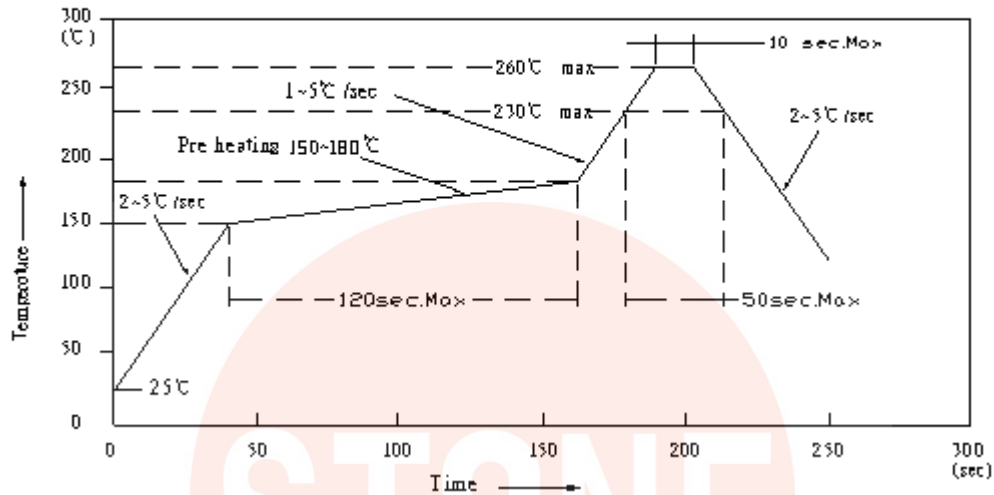

**IR Reflow Soldering Profile  
Lead Solder**

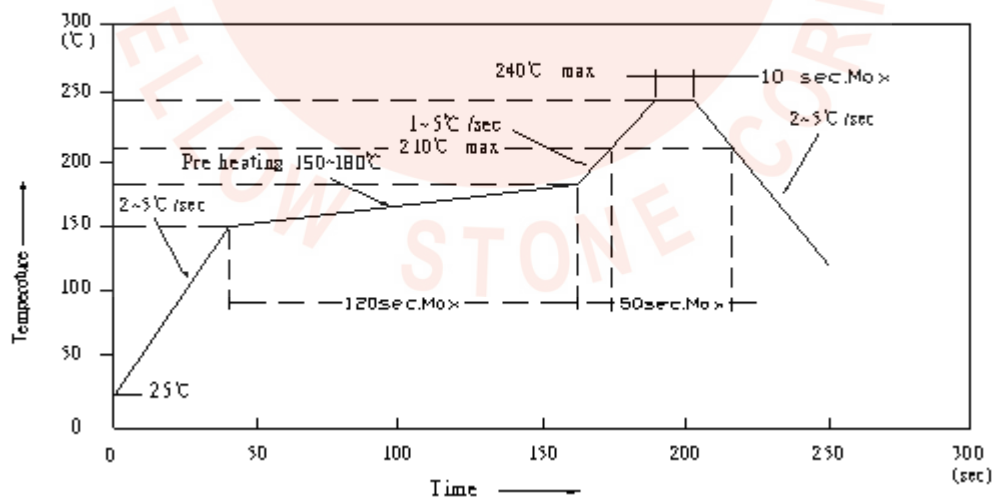

#### NOTES:

1. We recommend the reflow temperature 240°C (±5°C). the maximum soldering temperature should be limited to 260°C.
2. Don't cause stress to the silicone resin while it is exposed to high temperature.
3. Number of reflow process shall be 1 time.

## Test circuit and handling precautions

### ■ Test circuit

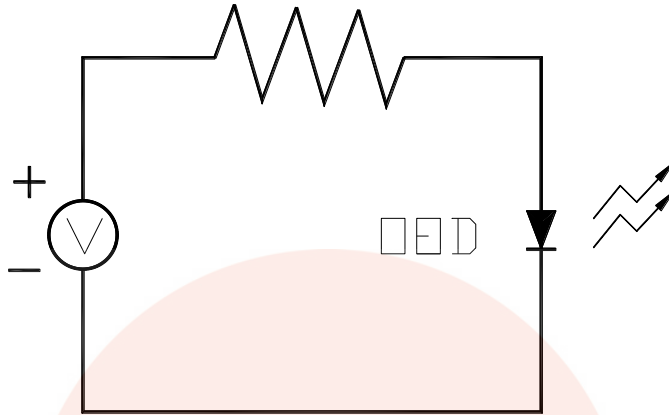

### ■ Handling precautions

#### 1. Over-current-proof

Customer must apply resistors for protection; otherwise slight voltage shift will cause big current change (Burn out will happen).

#### 2.Storage

2.1 It is recommended to store the products in the following conditions:

Humidity: 60% R.H. Max.

Temperature : 5°C~30°C (41°F~86°F)

2.2 Shelf life in sealed bag: 12 month at <math> < 5^{\circ}\text{C} \sim 30^{\circ}\text{C}</math> and <math> < 60\% \text{ R.H.}</math> after the package is Opened, the products should be used within a week or they should be keeping to stored at  $\leq 20\% \text{ R.H.}$  with zip-lock sealed.

#### 3.Baking

It is recommended to baking before soldering when the pack is unsealed after 24hrs. The Conditions are as followings:

3.1  $70 \pm 3^{\circ}\text{C}$  x(12~24hrs) and <math> < 5\% \text{ RH}</math>, taped reel type

3.2  $100 \pm 3^{\circ}\text{C}$  x(45min~1hr), bulk type

3.3  $130 \pm 3^{\circ}\text{C}$  x(15~30min), bulk type

## Test items and results of reliability

Type	Test Item	Test Conditions	Note	Number of Damaged
Environmental Sequence	Temperature Cycle	-45°C 30min ↑ ↓ 20 min 105°C 30min	100 cycle	0/22
	Thermal Shock	-10°C 15min ↑ ↓ 5sec 100°C 15min	100 cycle	0/22
	High Humidity Heat Cycle	30°C ⇔ 65°C 90%RH 24hrs/1cycle	10 cycle	0/22
	High Temperature Storage	T <sub>a</sub> =100°C	1000 hrs	0/22
	Humidity Heat Storage	T <sub>a</sub> =85°C RH=85%	1000 hrs	0/22
	Low Temperature Storage	T <sub>a</sub> =-40°C	1000 hrs	0/22
Operation Sequence	Life Test	T <sub>a</sub> =25°C I <sub>F</sub> =60mA	1000 hrs	0/22
	High Humidity Heat Life Test	85°C RH=85% I <sub>F</sub> =30mA	500 hrs	0/22
	Low Temperature Life Test	T <sub>a</sub> =-20°C I <sub>F</sub> =60mA	1000 hrs	0/22

## 5050 Single-Color High Performance SMD Top LEDs Packaging Specifications

- Feeding Direction

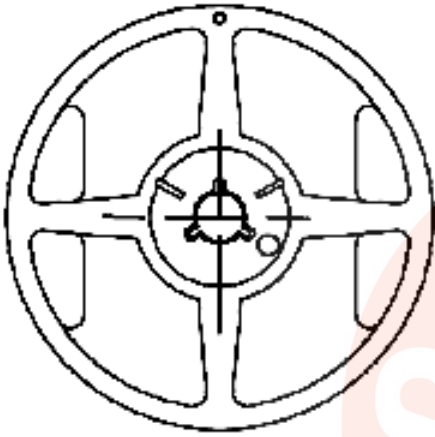

- Dimensions of Reel (Unit: mm)

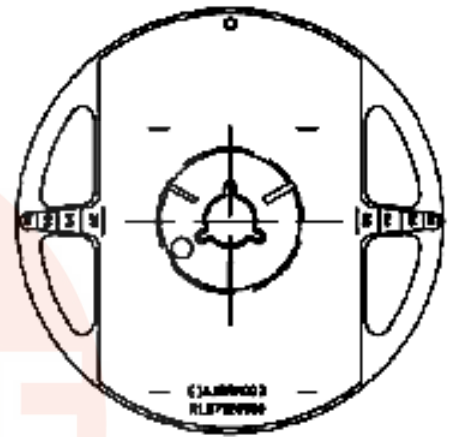
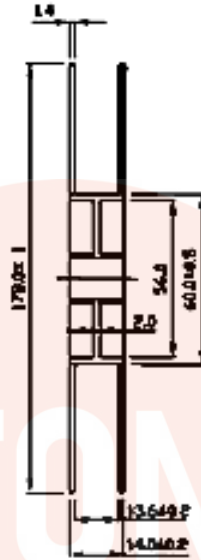

- Dimensions of Tape (Unit: mm)

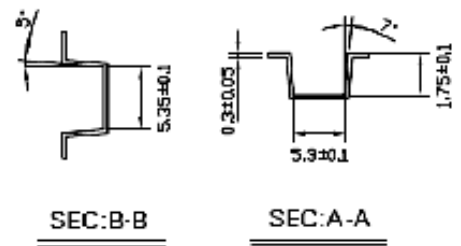
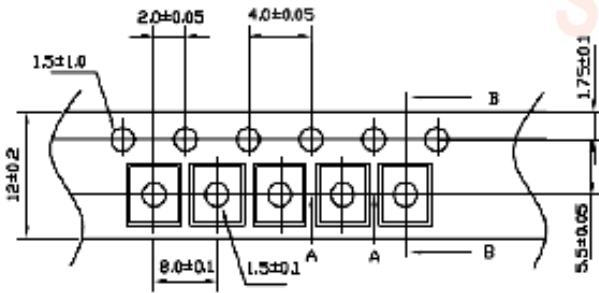

### NOTES

1. Empty component pockets are sealed with top cover tape;
2. The maximum number of missing smds is two;
3. The cathode is oriented towards the tape sprocket hole in accordance with ANSI/EIA RS-481 specifications;
4. 1,000pcs/Reel



## LED Usage and Handling Instructions

### No.1 、Soldering :

A 、It is not better to be manual soldering.

B 、Reflow soldering :

1 、Soldering according to the following temperature chart is highly recommended

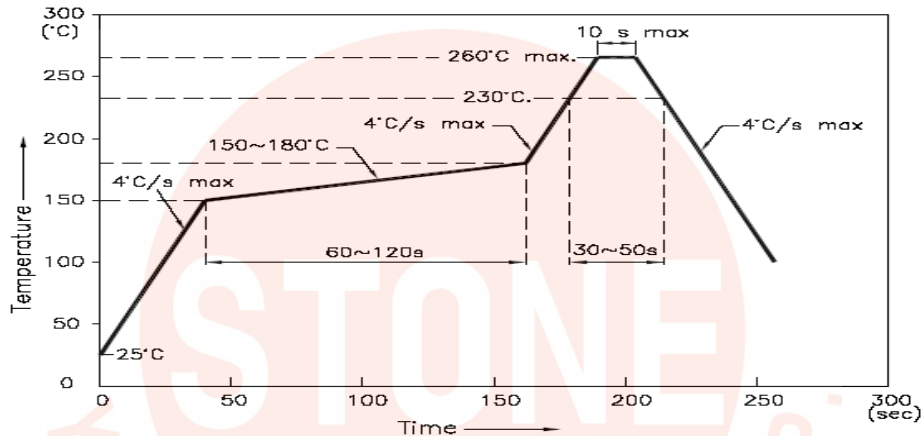

2 、Soldering paste

Use soldering paste with the melting point at 230°C is recommended

### No.2 、Collet

1 、Abnormal situation caused by improper setting of collet

To choose the right collet is the key issue in improving the product's quality. LED is different from other electronic components, which is not only about electrical output but also for optical output. This characteristic made LED more fragile in the process of SMT. If the collet's lowering down height is not well set, it will bring damage to the gold wire at the time of collet's picking up and loading which will cause the LED fail to light up, light up now and then or other quality problems

2 、How to choose the collet

During SMT, please choose the collet that has larger outer diameter than the lighting area of lens, in case that improper position of collet will damage the gold wire inside the LED. Different collets fit for different products, please refer to the following pictures cross out:

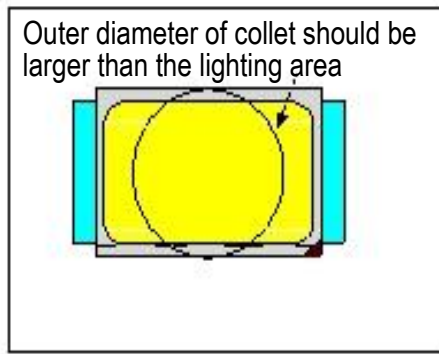

Picture 1 (√)

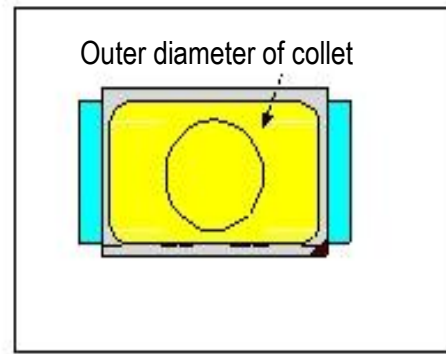

Picture 2 (×)

### 3、How to set the height of collet

The reason why for top view SMD, the height of collet before it presses downward will directly affect the quality of products during SMT is that if the collet go down too much, it will press lens and cause the distortion or breaking of gold wire. The setting of collet position should follow the pictures belowed.

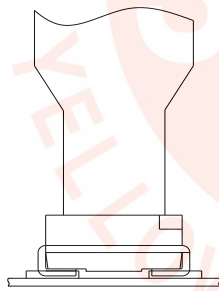

Picture 3 (√)

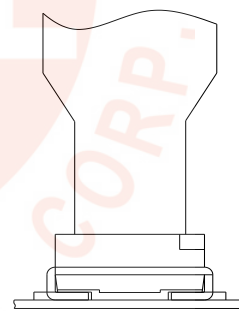

Picture 4 (×)

### No.3、Other points for attention

- A、No pressure should be exerted to the epoxy shell of the SMD under high temperature.
- B、Do not scratch or wipe the lens since the lens and gold wire inside are rather fragile and cross out easy to break.
- C、LED should be used as soon as possible when being taken out of the original package, and should be stored in anti-moisture and anti-ESD package.

No.4、This usage and handling instruction is only for your reference.